

# 20.20.1319.00

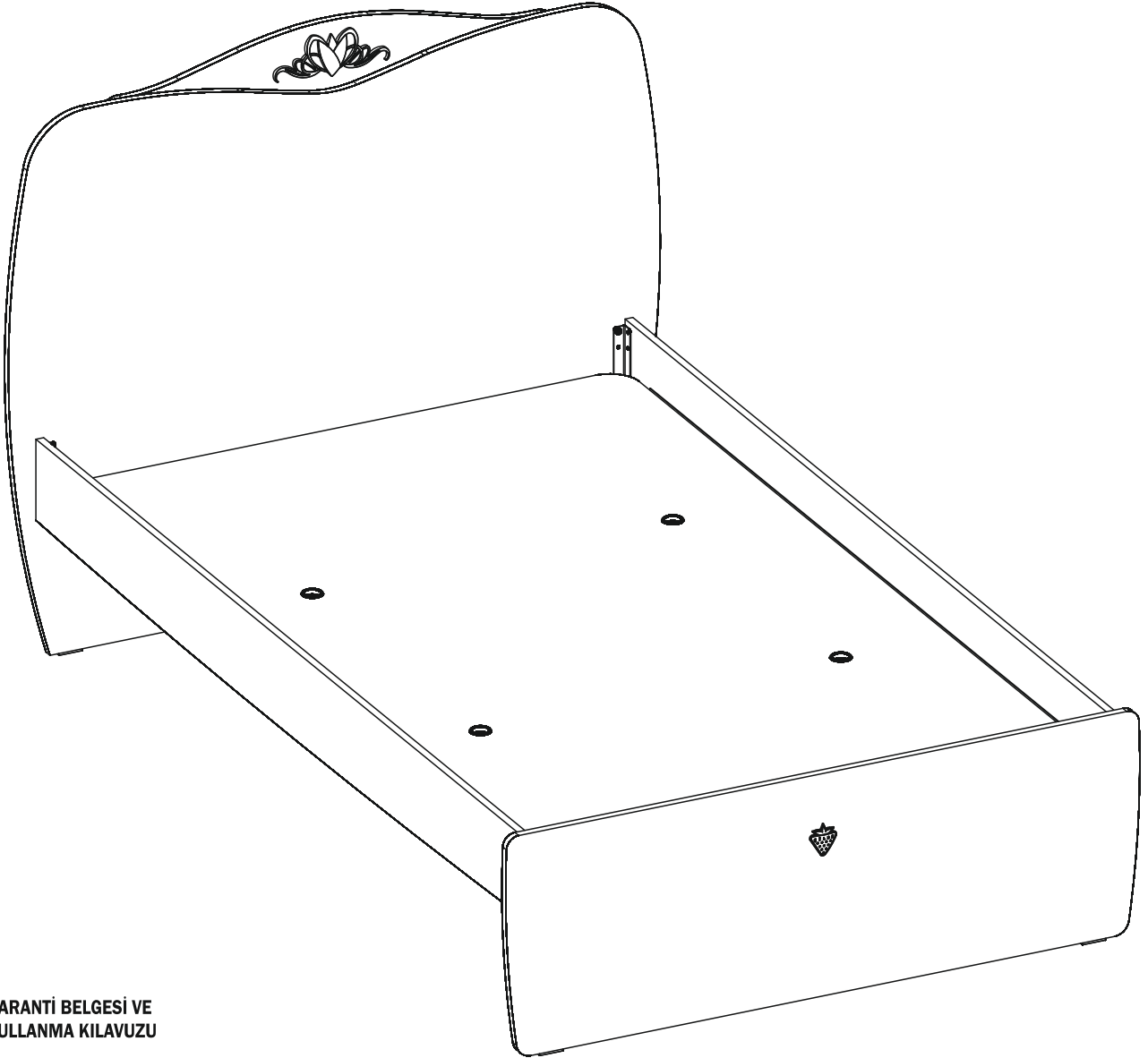

GARANTİ BELGESİ VE  
KULLANMA KILAVUZU



WARRANTY CERTIFICATE  
AND USER MANUAL

شهادة الضمان ودليل المستخدم



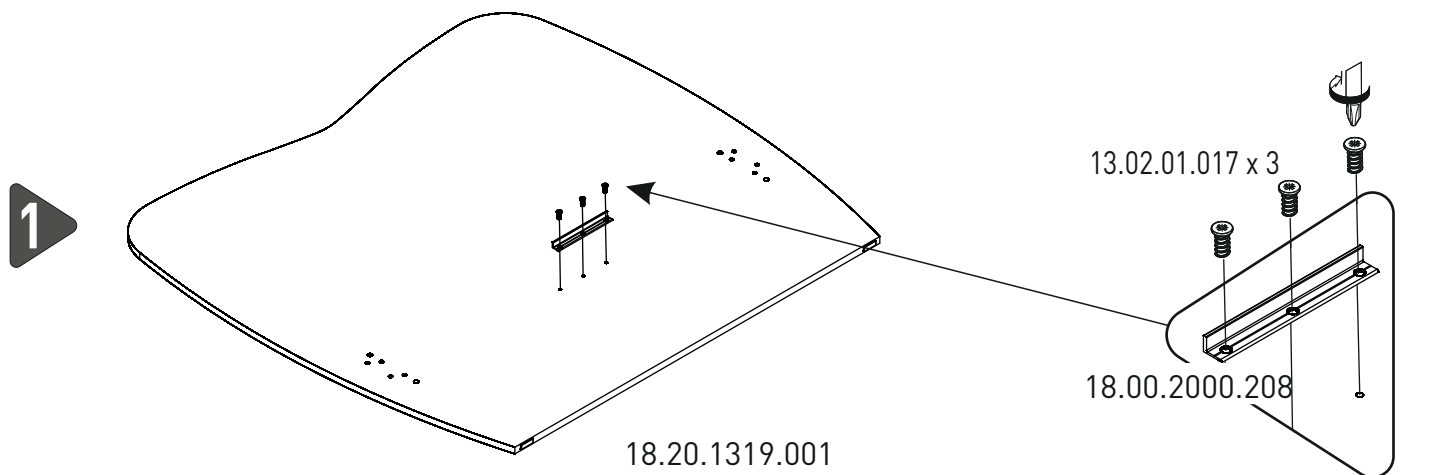
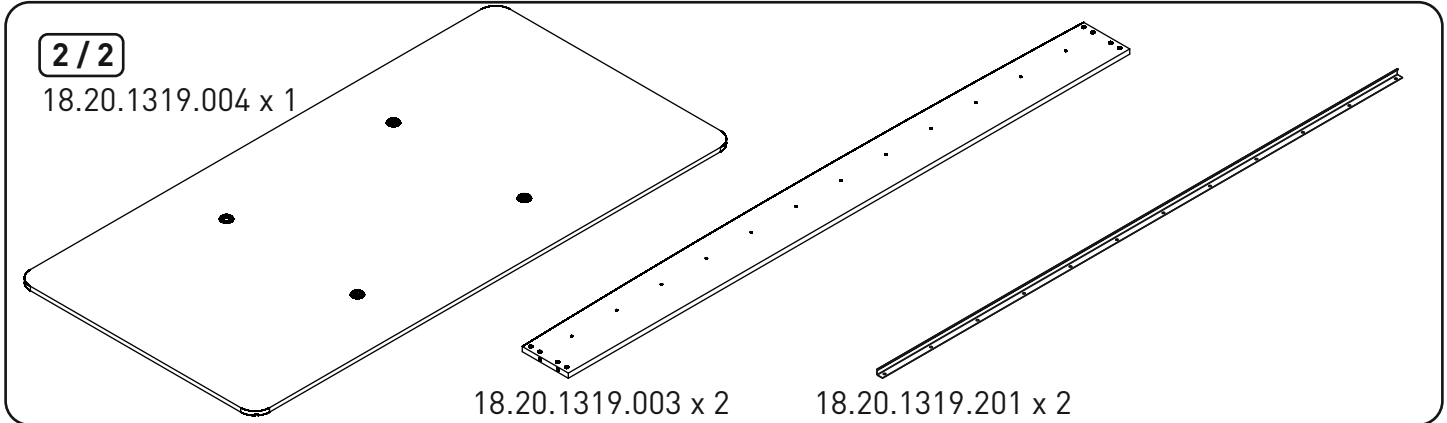
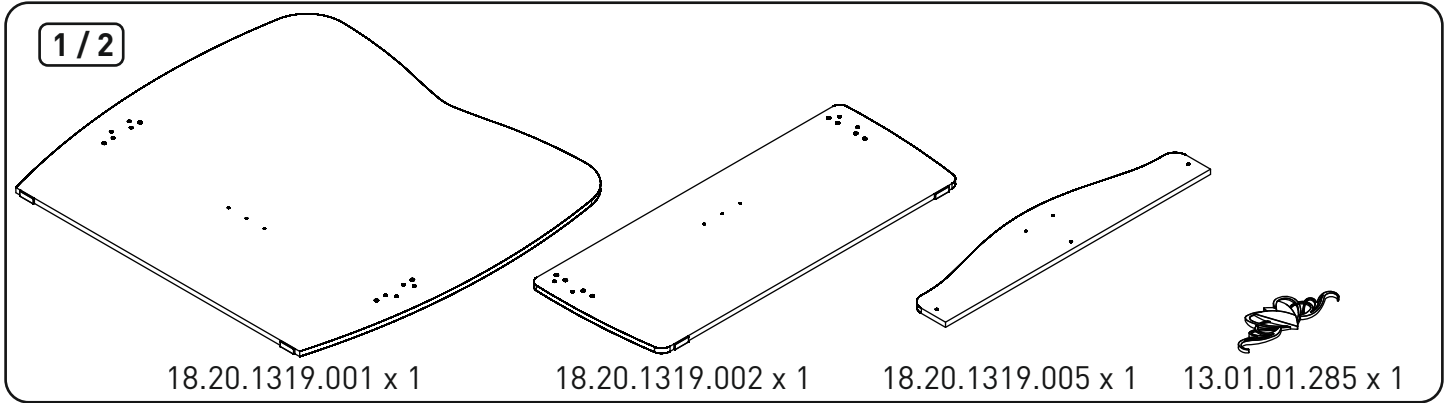
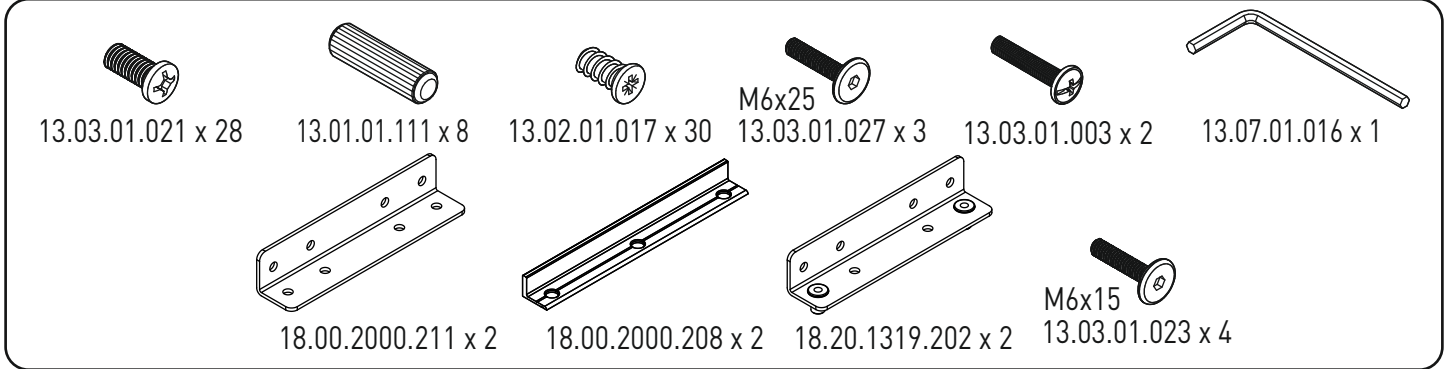
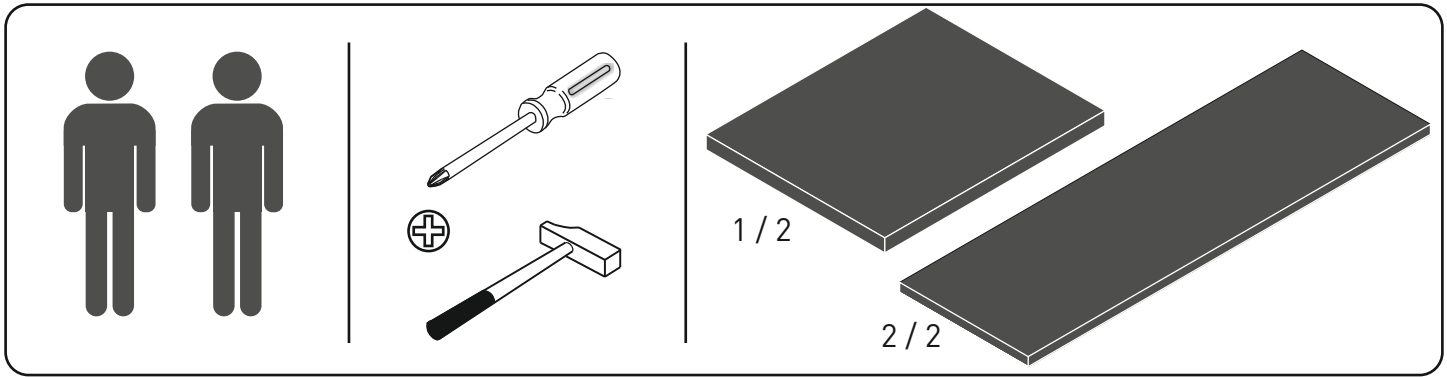

2

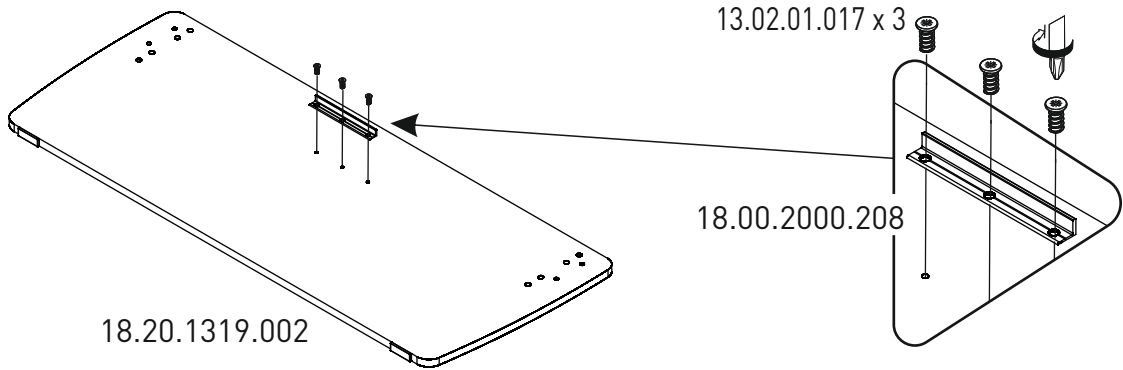

3

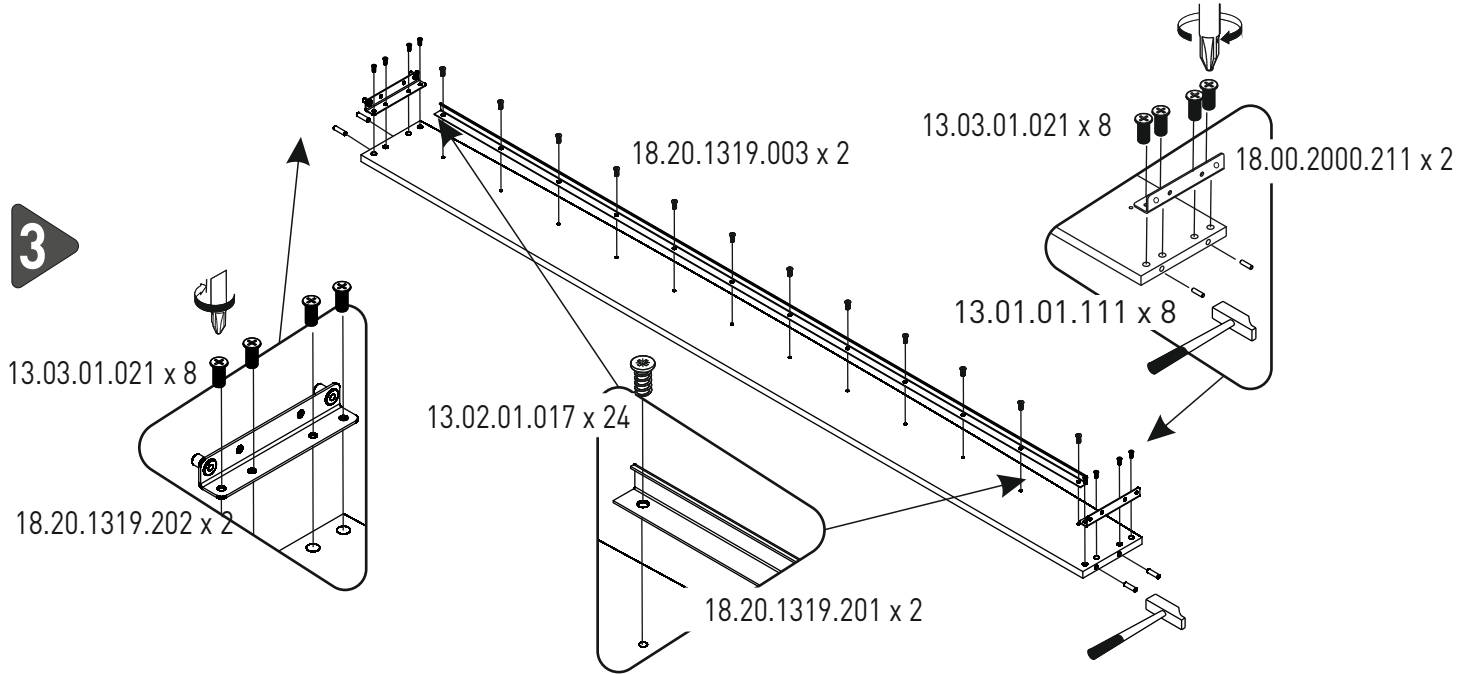

4

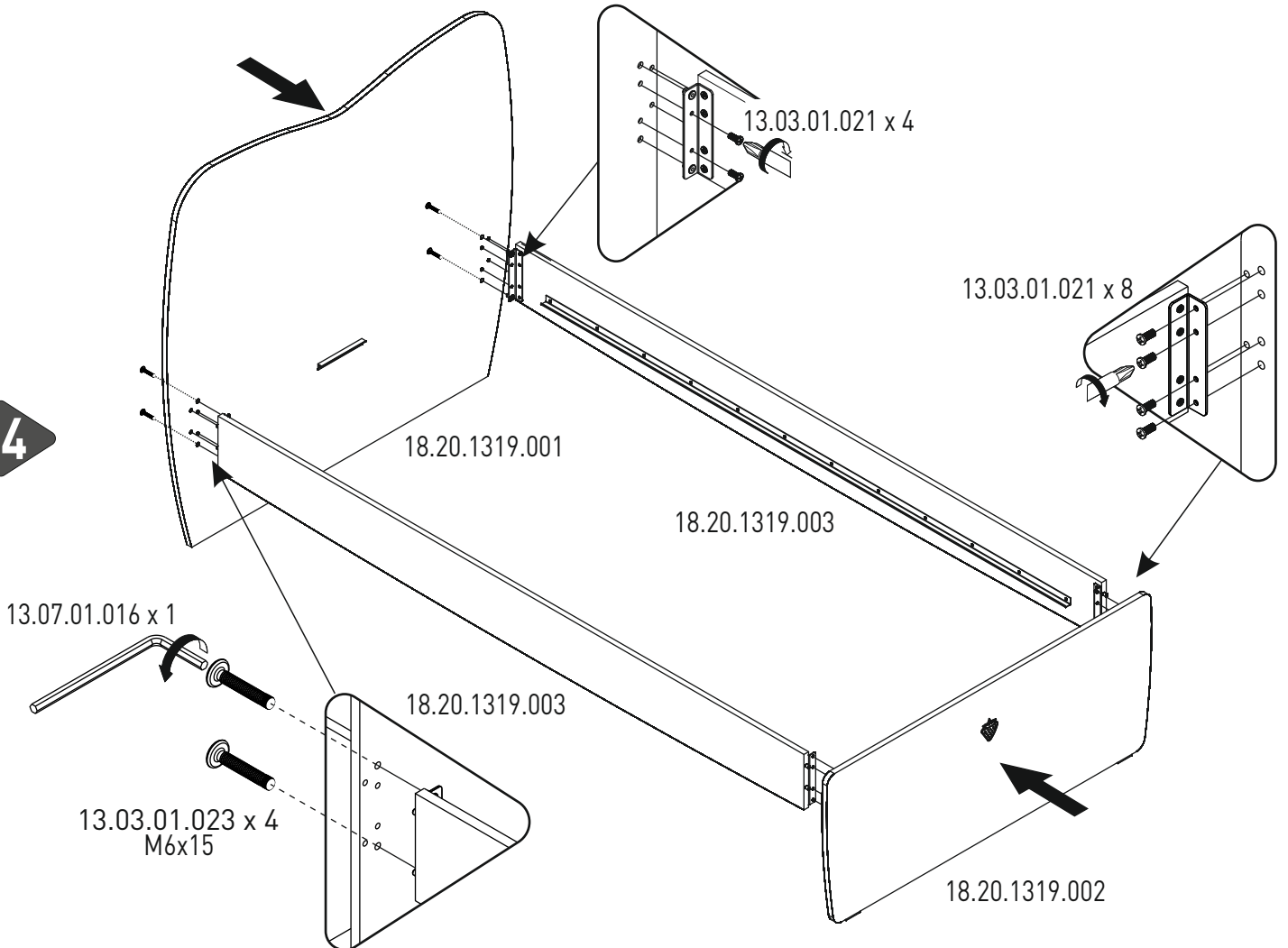

5

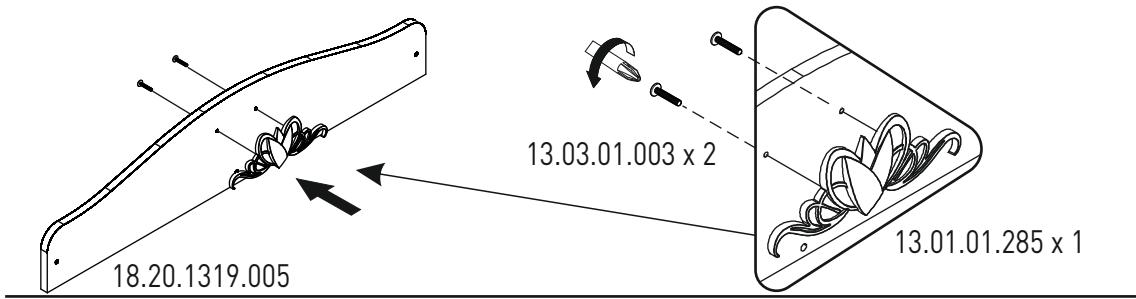

6

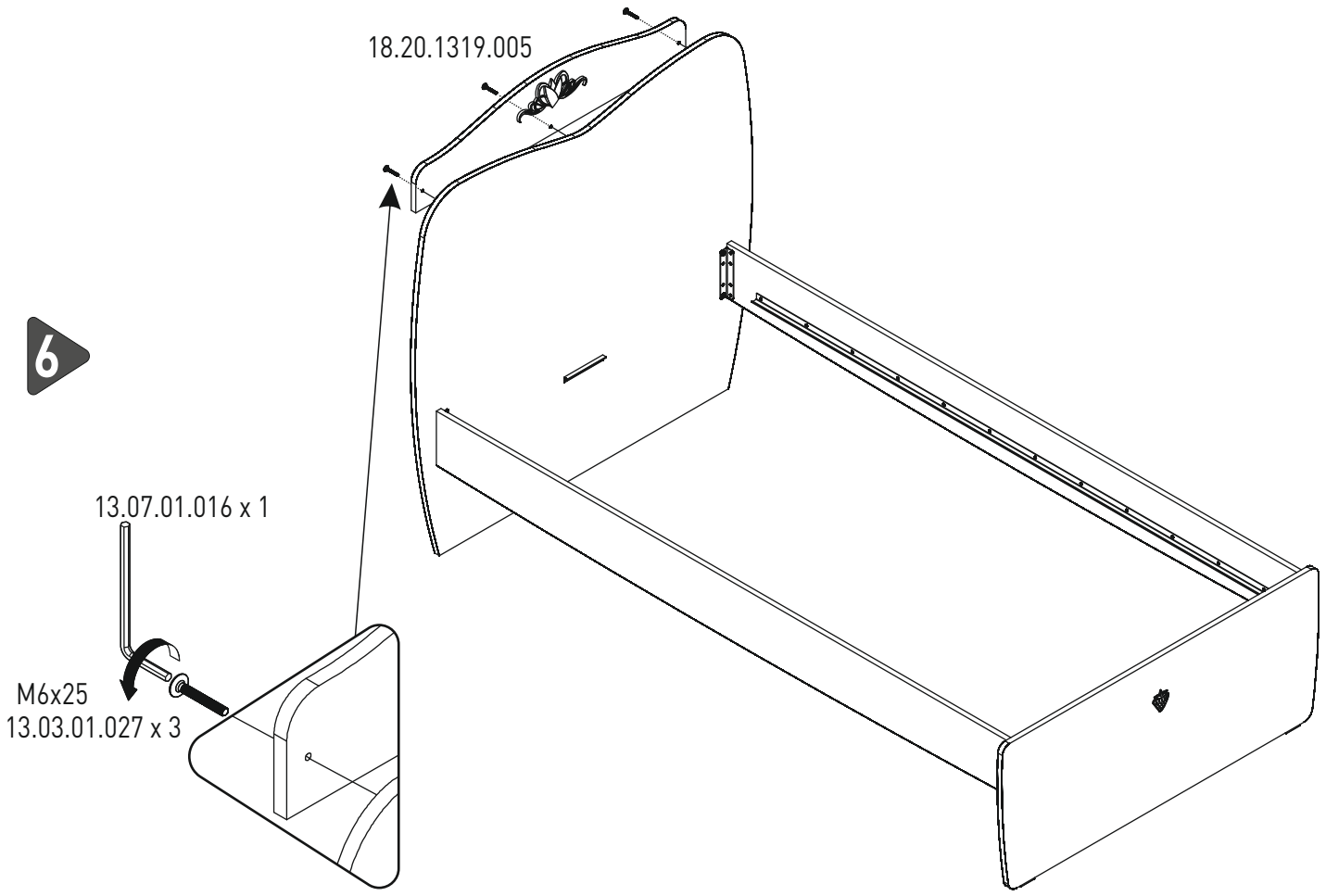

7

