

# 20.89.1505.00

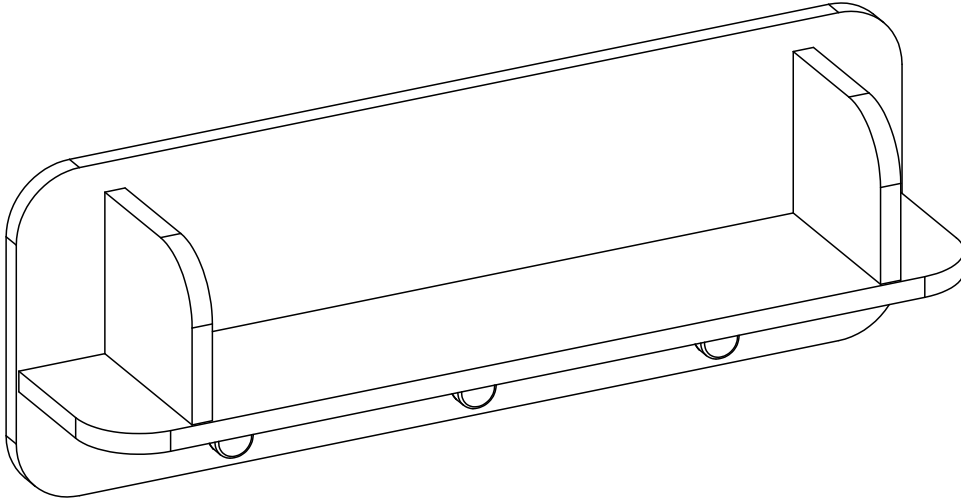

GARANTİ BELGESİ VE  
KULLANMA KILAVUZU



WARRANTY CERTIFICATE  
AND USER MANUAL

شهادة الضمان ودليل المستخدم



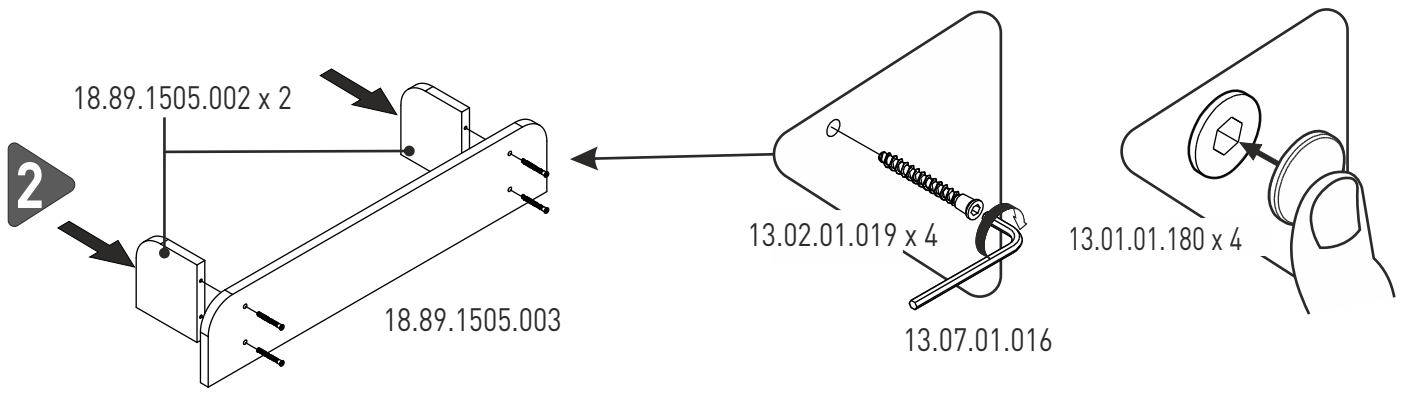
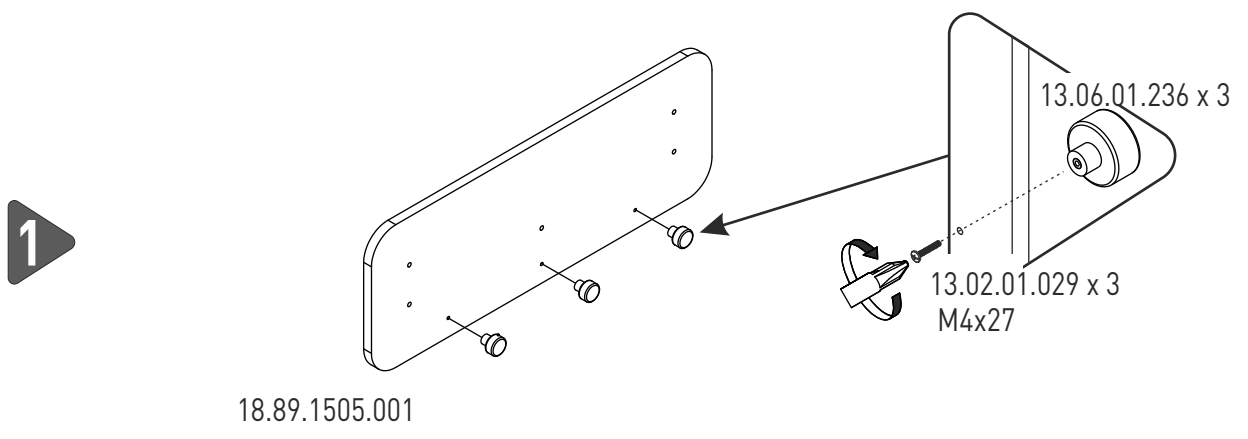
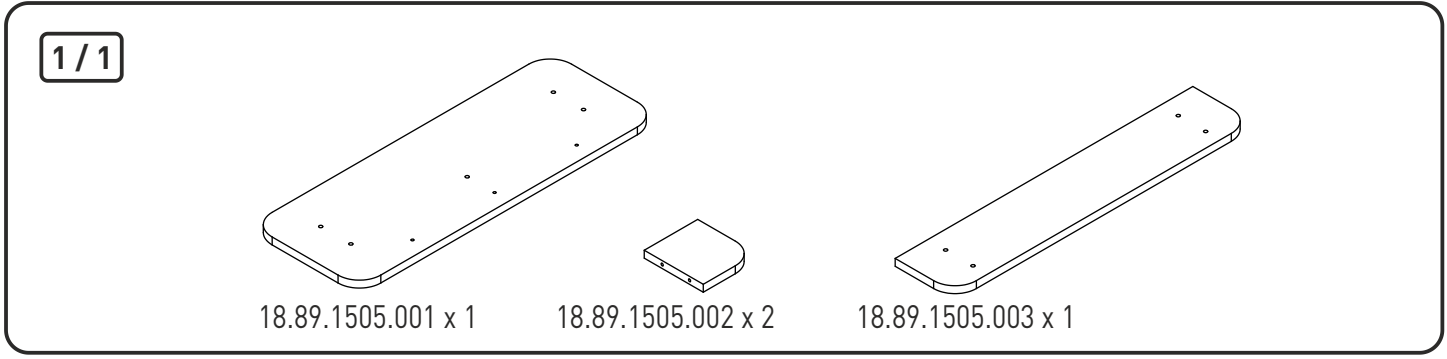
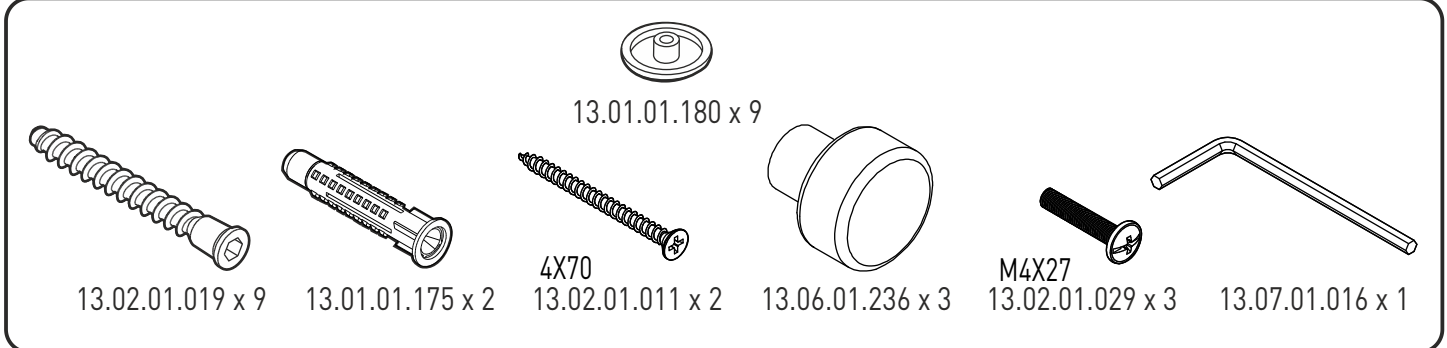
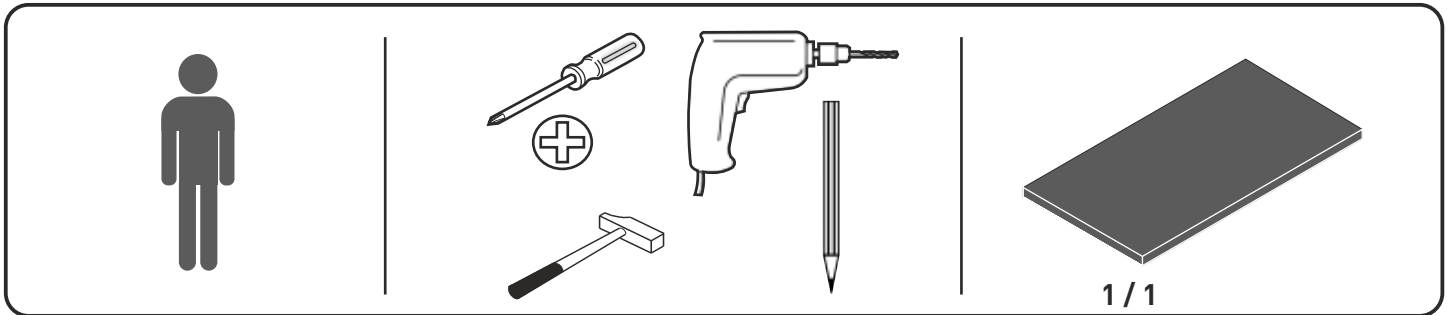

3

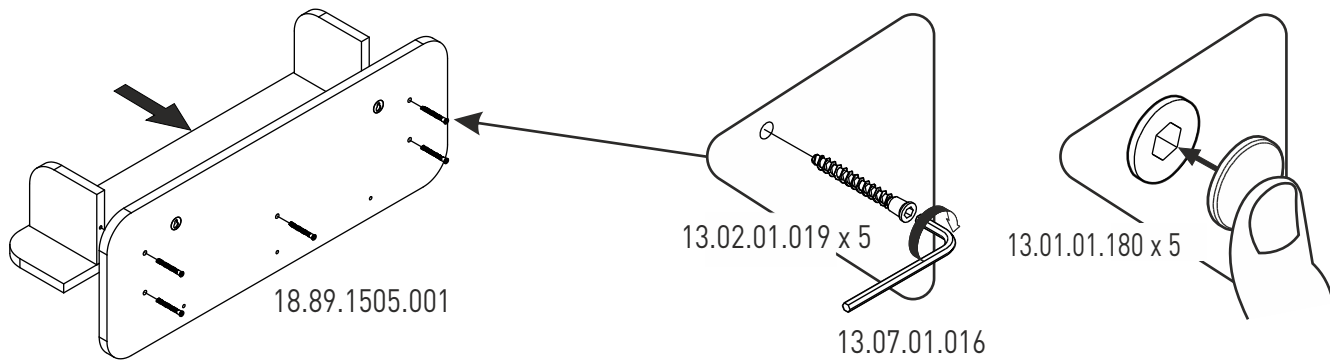

4

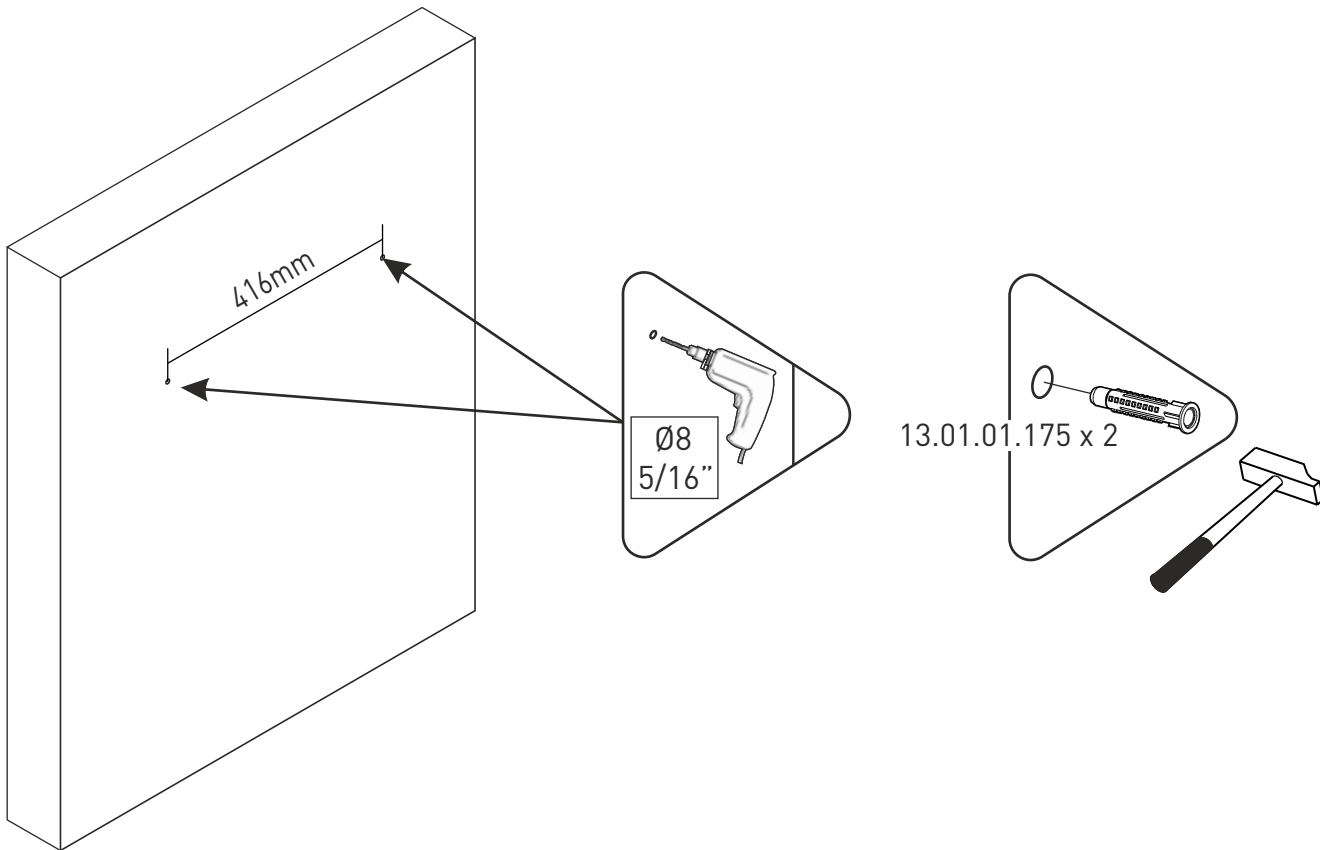

5

