

# 20.83.1013.00



GARANTİ BELGESİ VE  
KULLANMA KILAVUZU



WARRANTY CERTIFICATE  
AND USER MANUAL

شهادة الضمان ودليل المستخدم



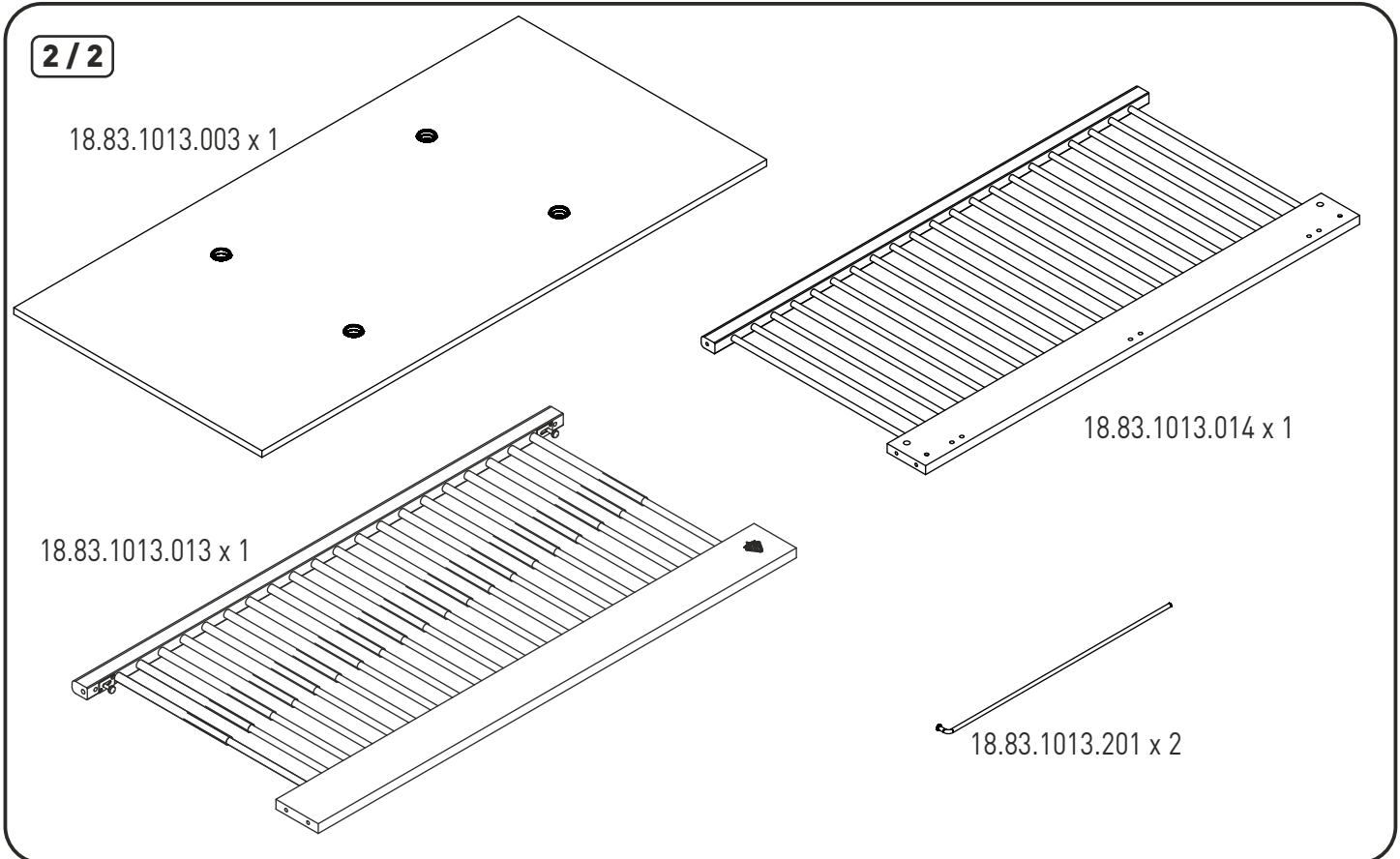
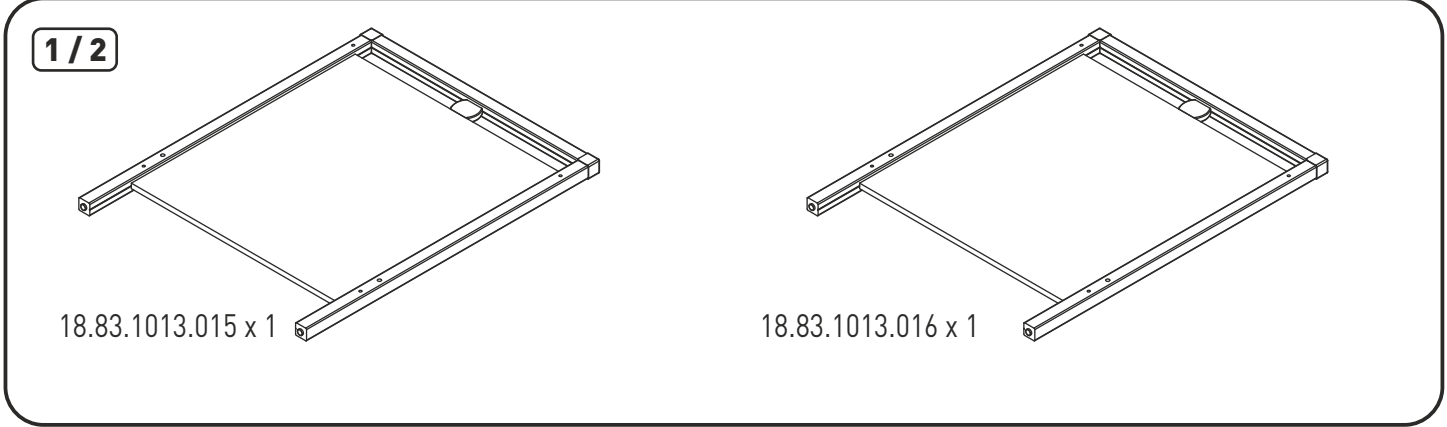
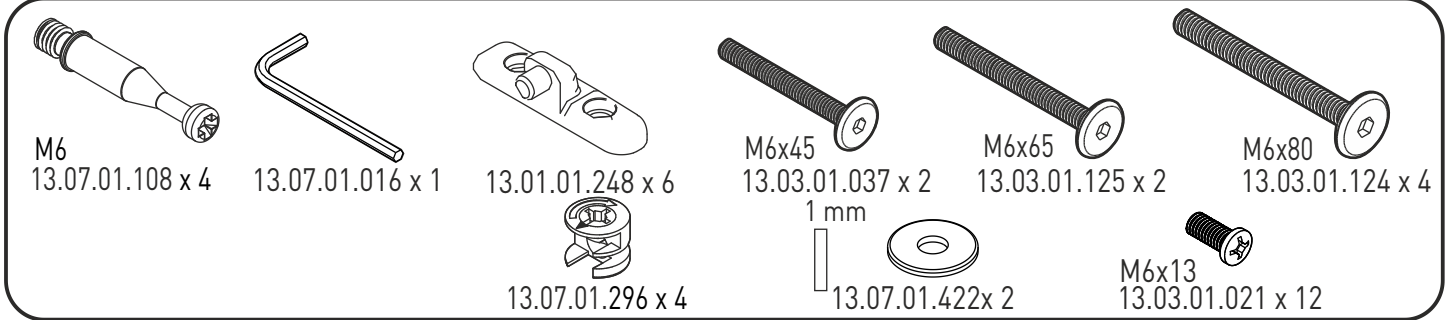
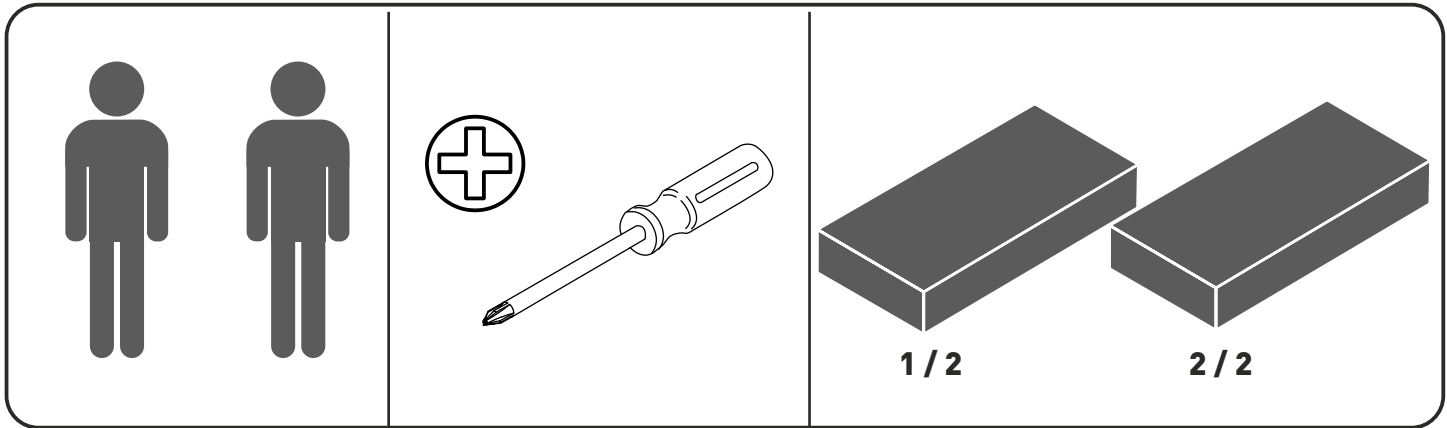

1

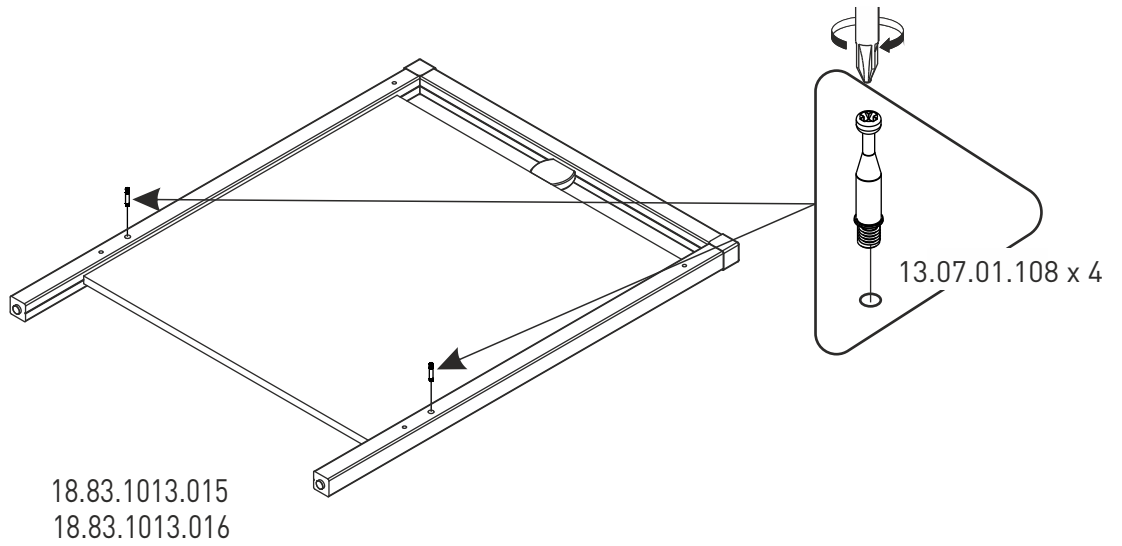

2

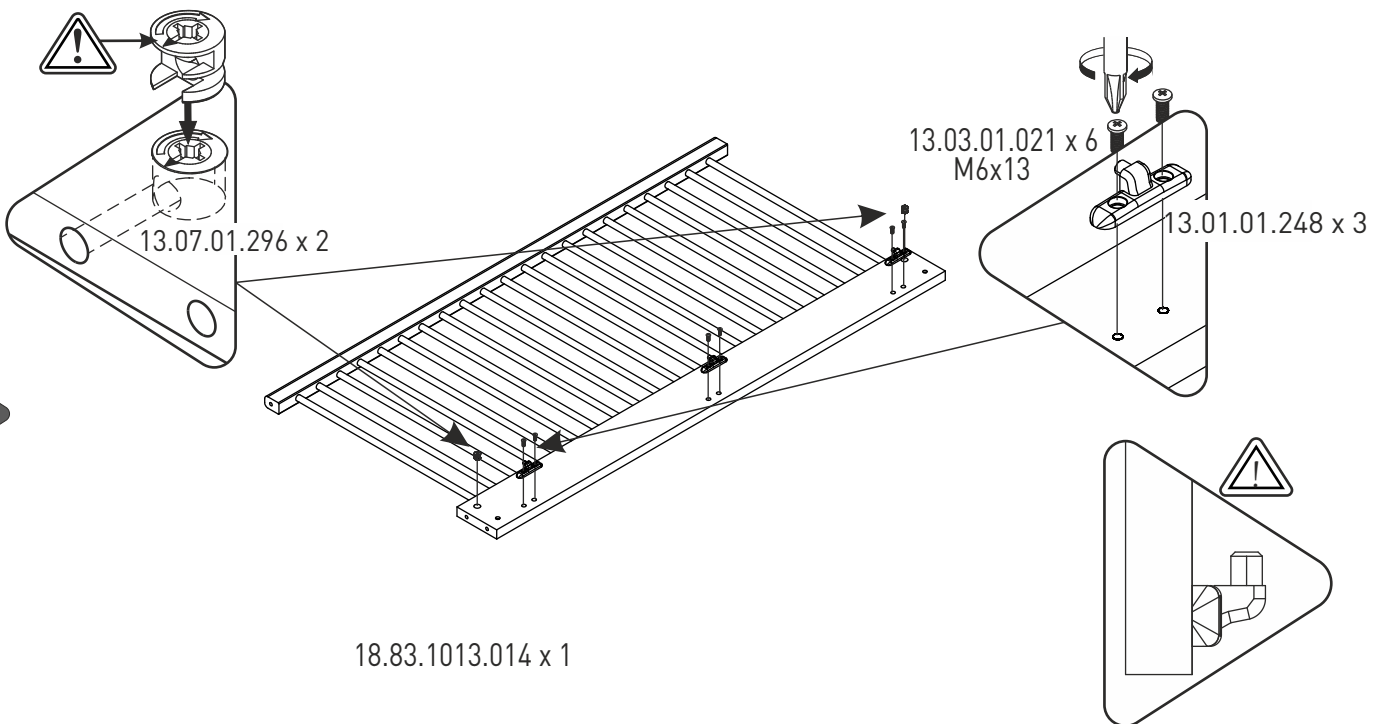

3

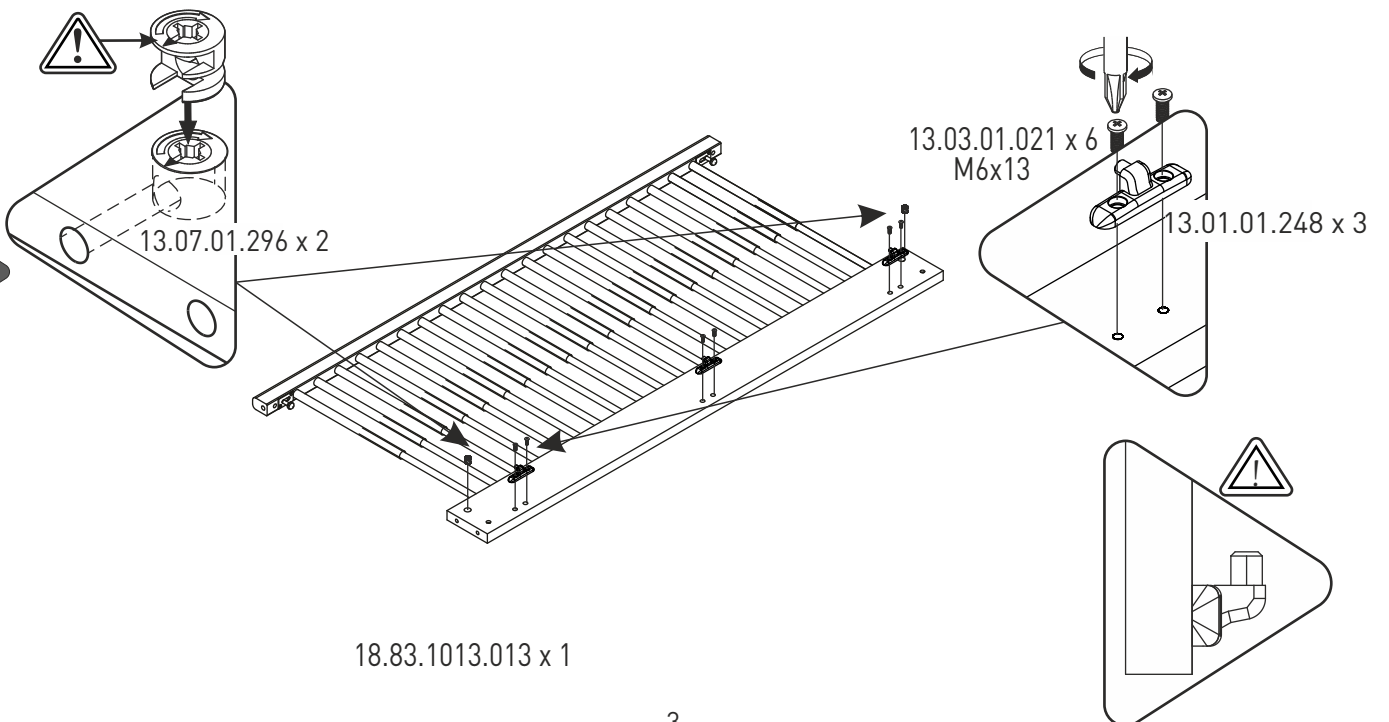

4

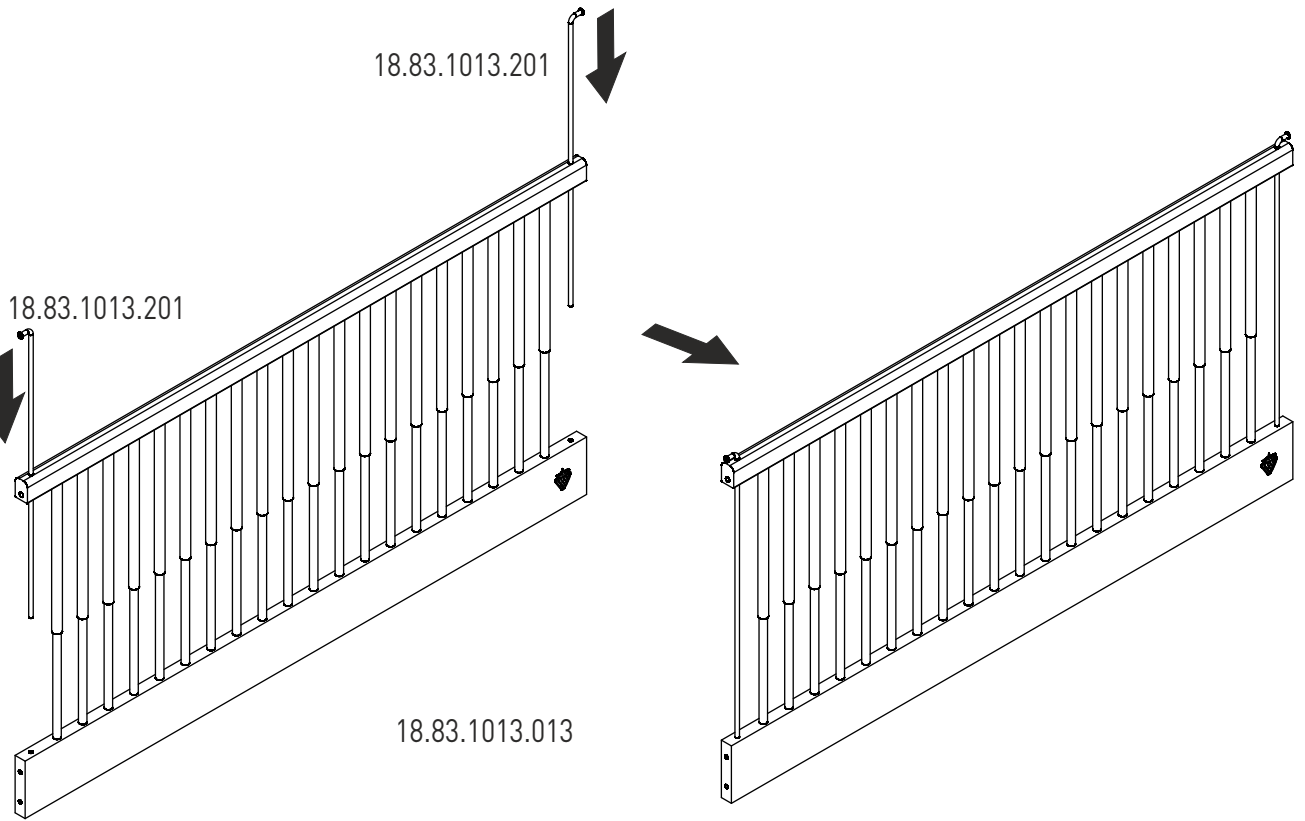

5

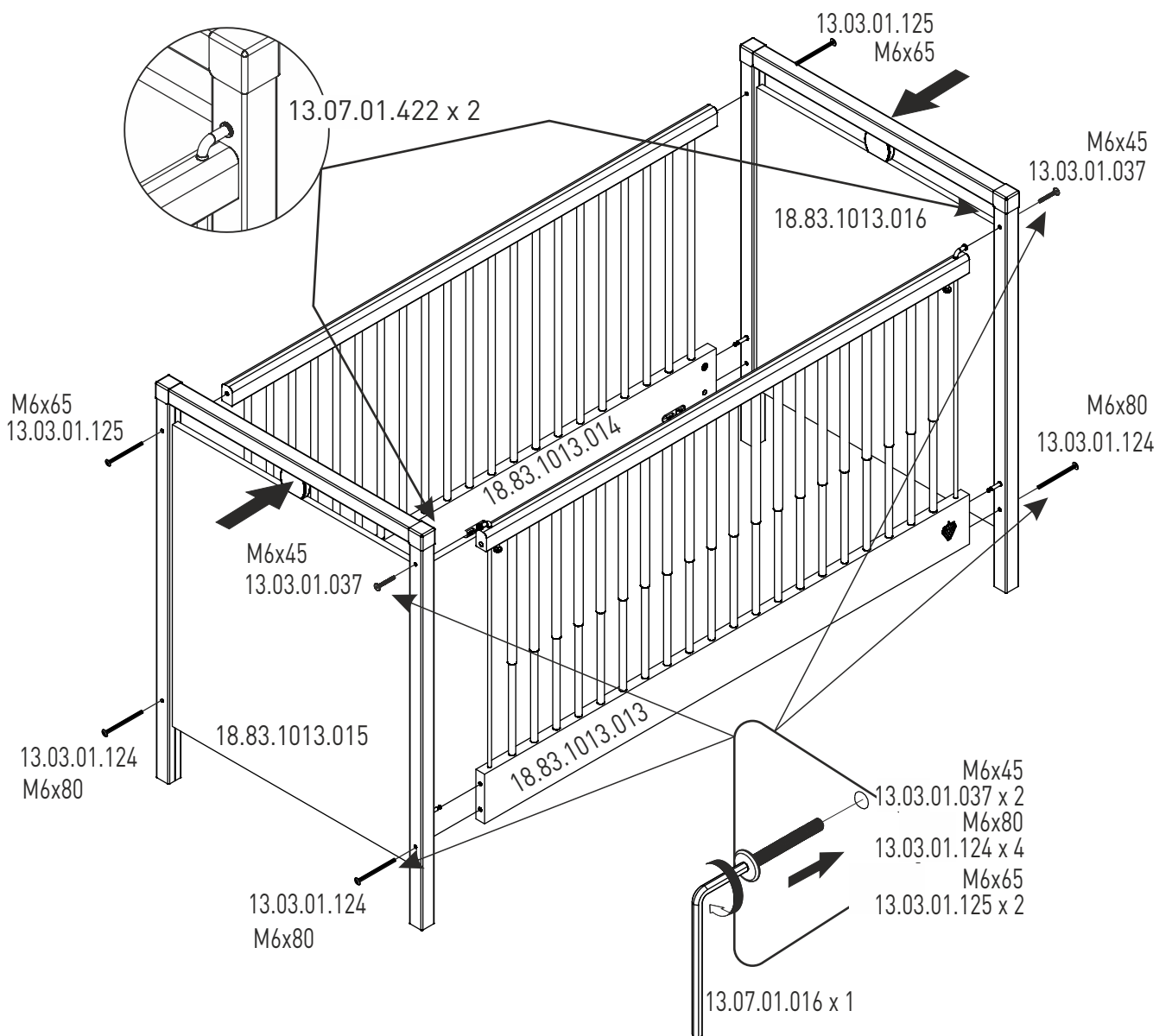

6

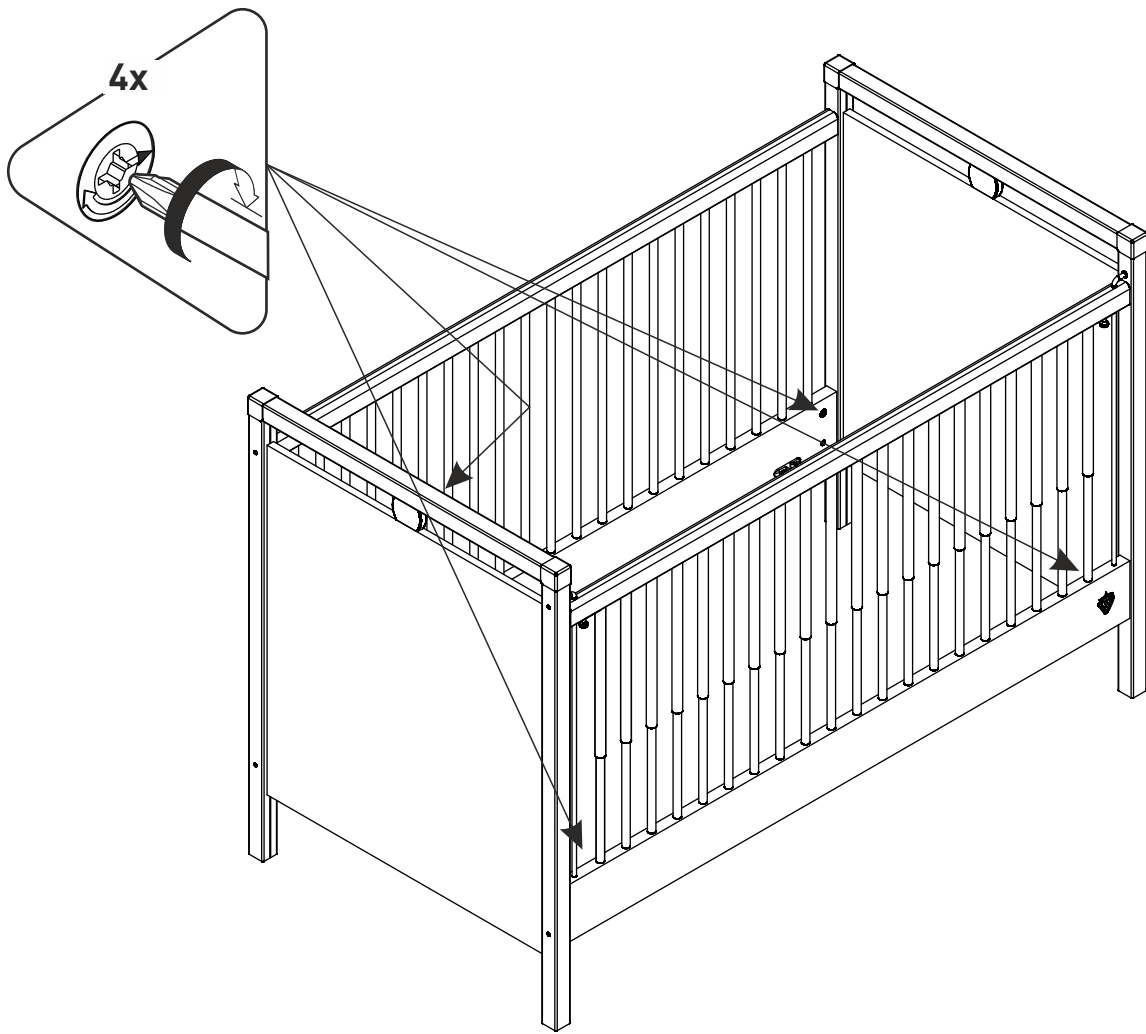

7

