

20.45.1702.00

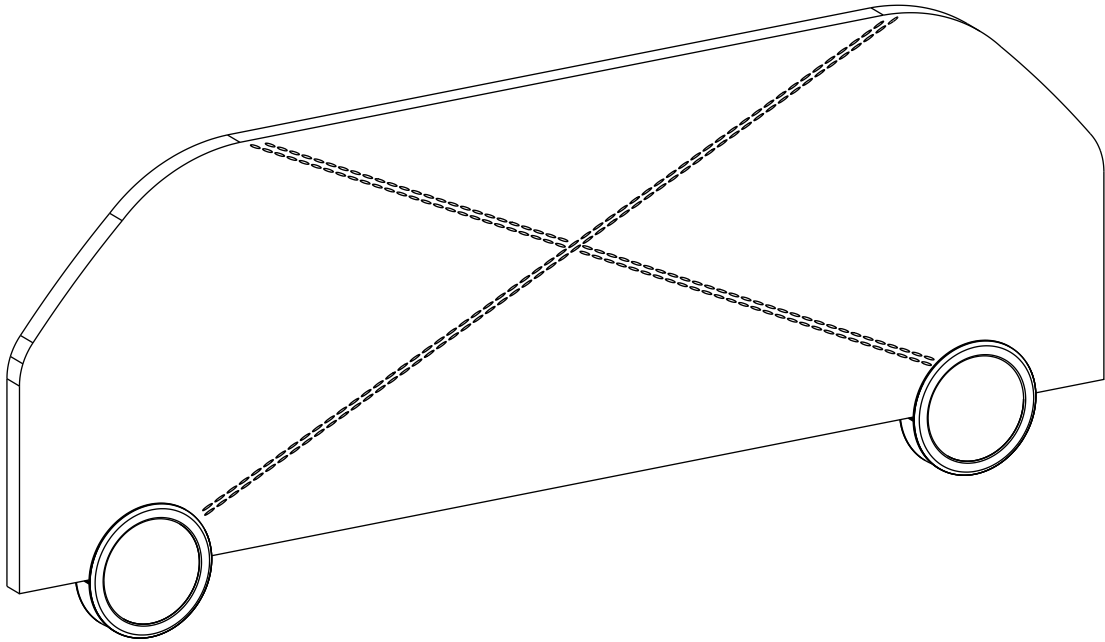

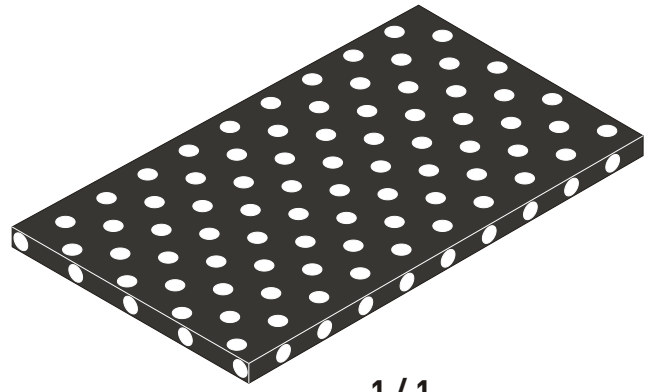

1 / 1

1 / 1

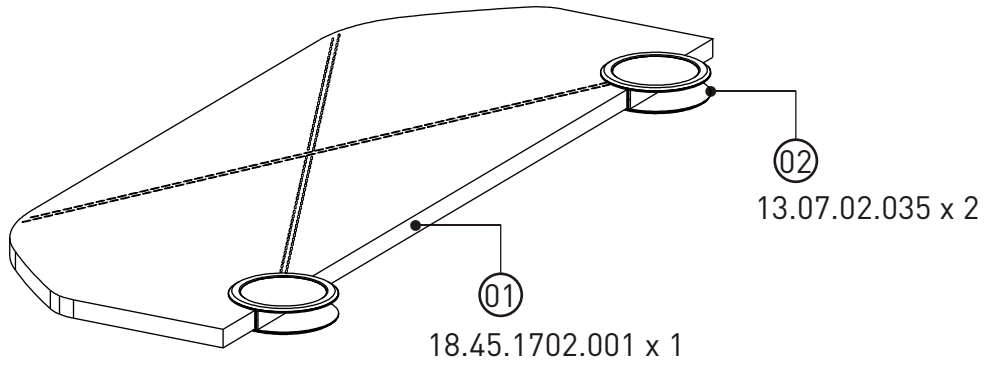

1

