

**20.37.1702.00**

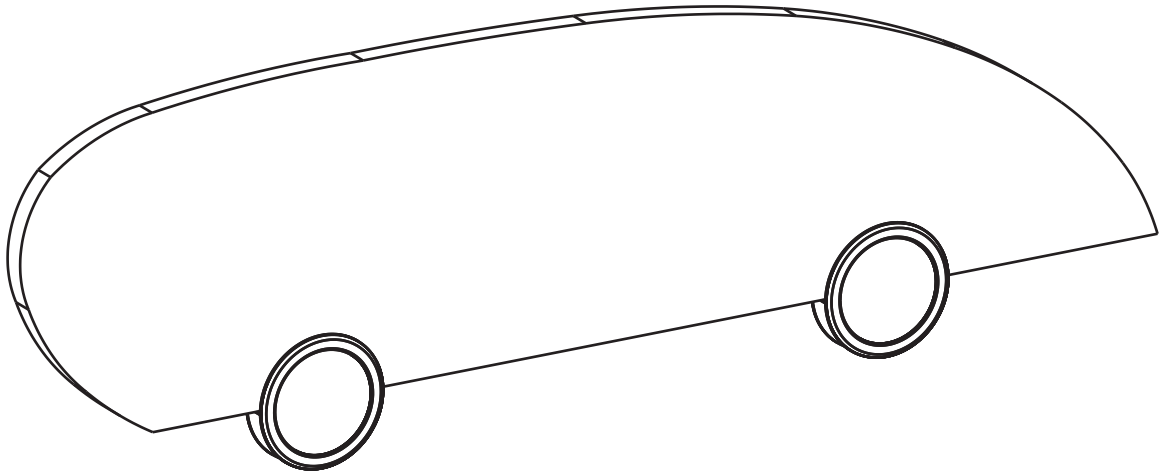

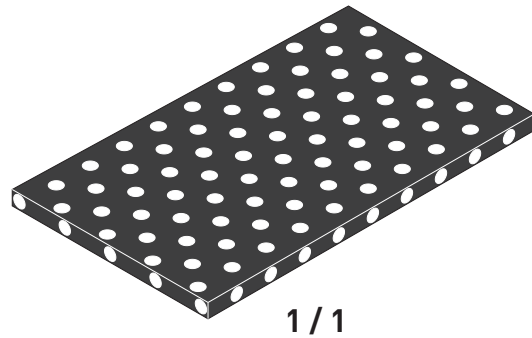
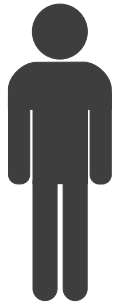

1 / 1

1 / 1

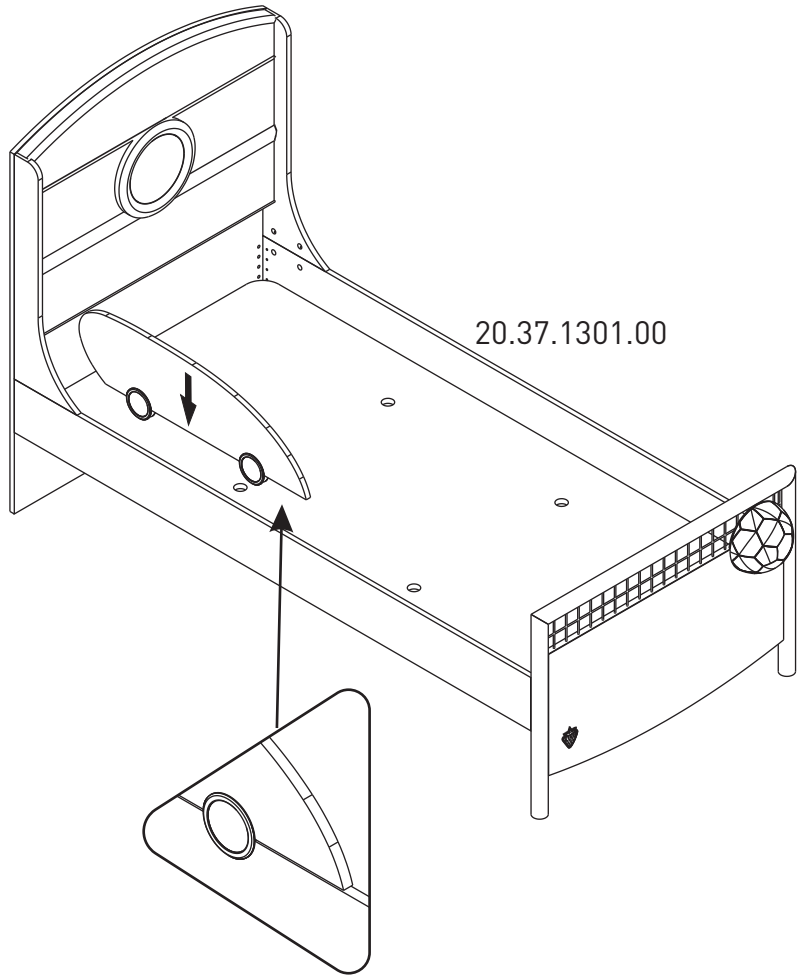
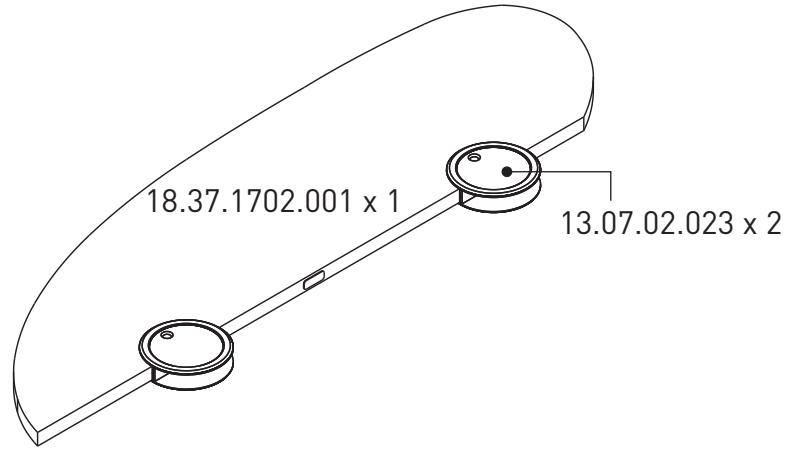

1