

20.20.1603.00

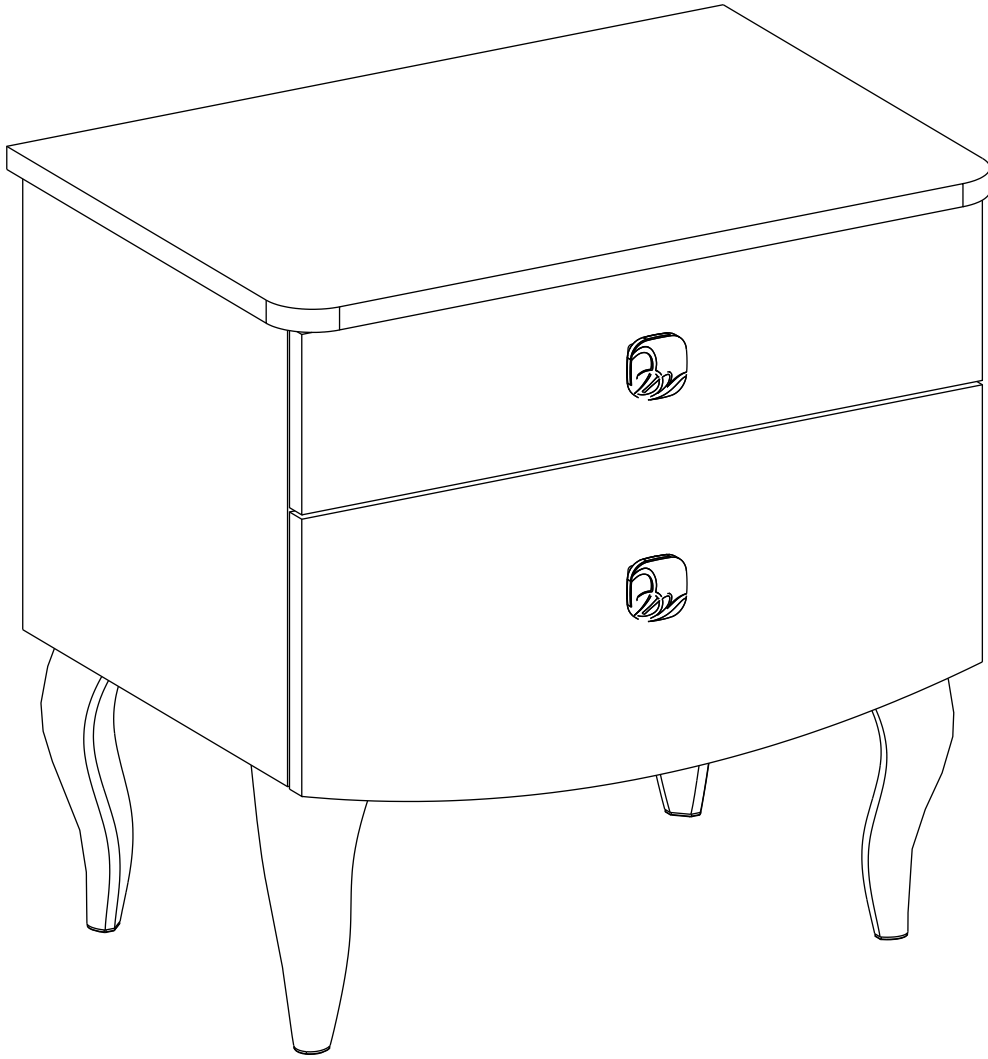

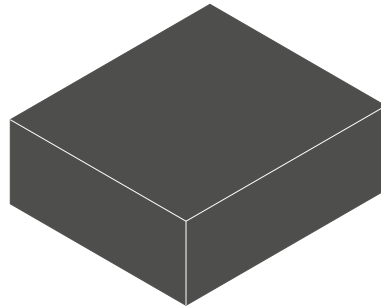

1 / 1

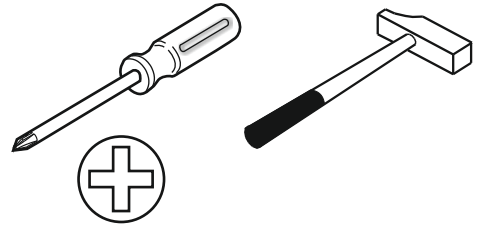
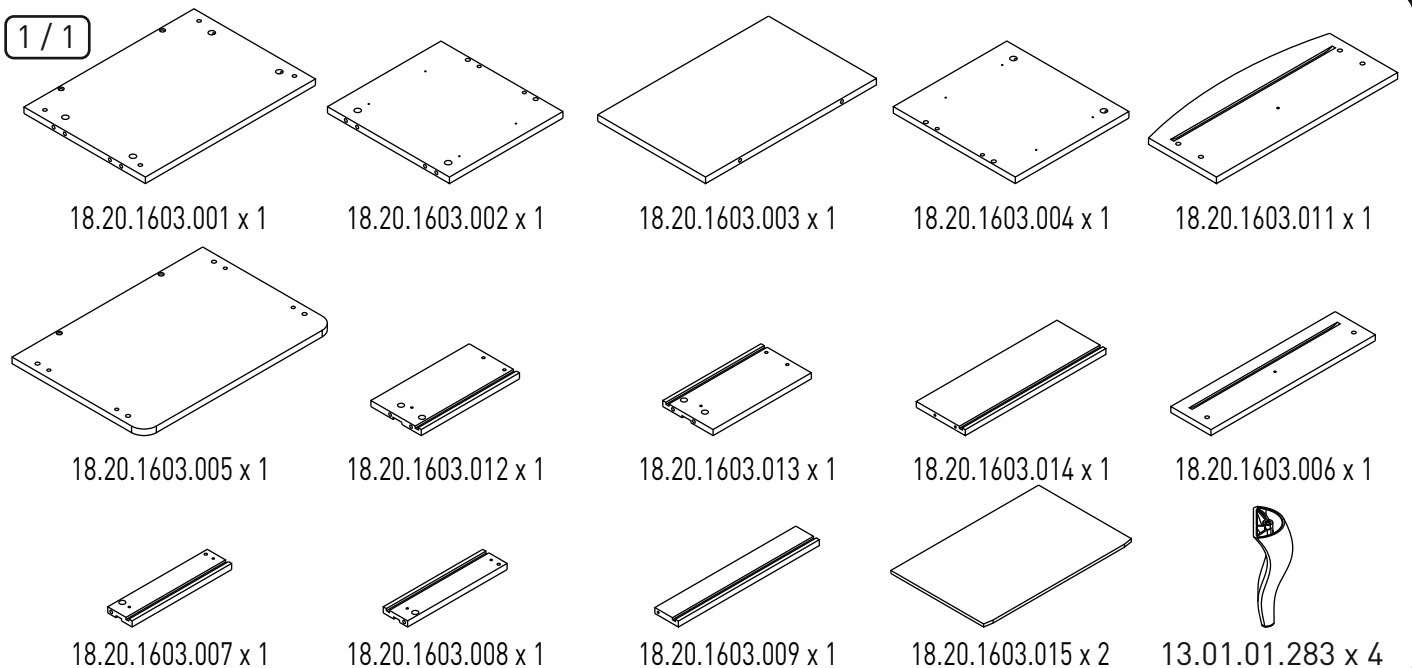
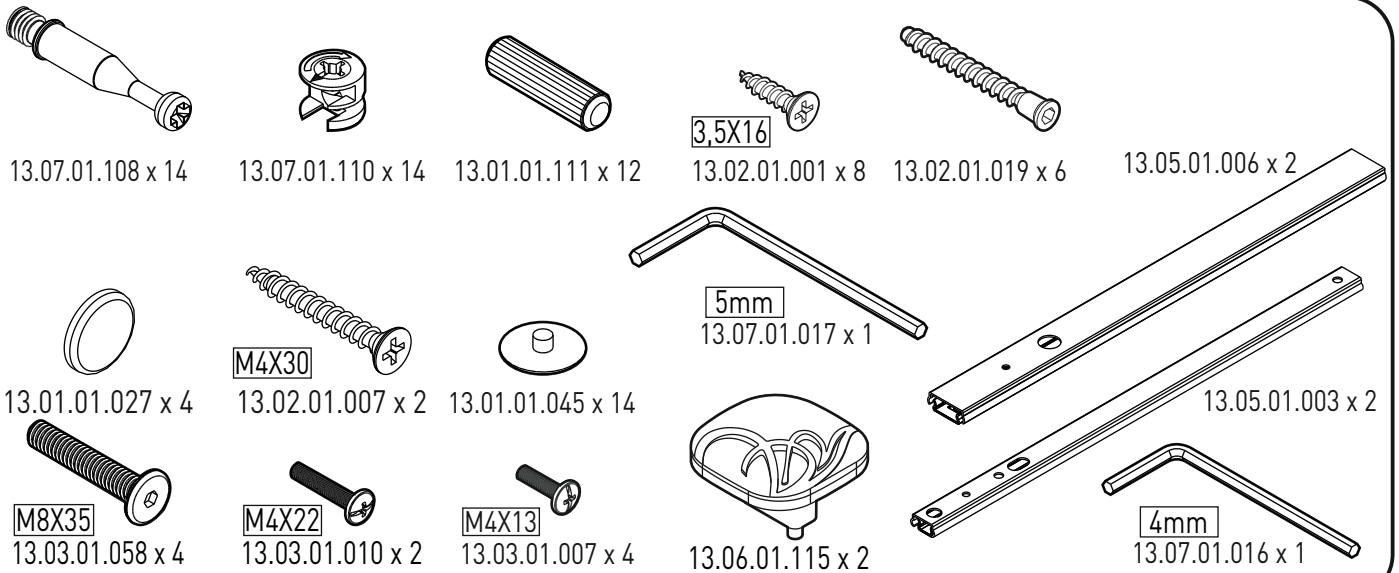

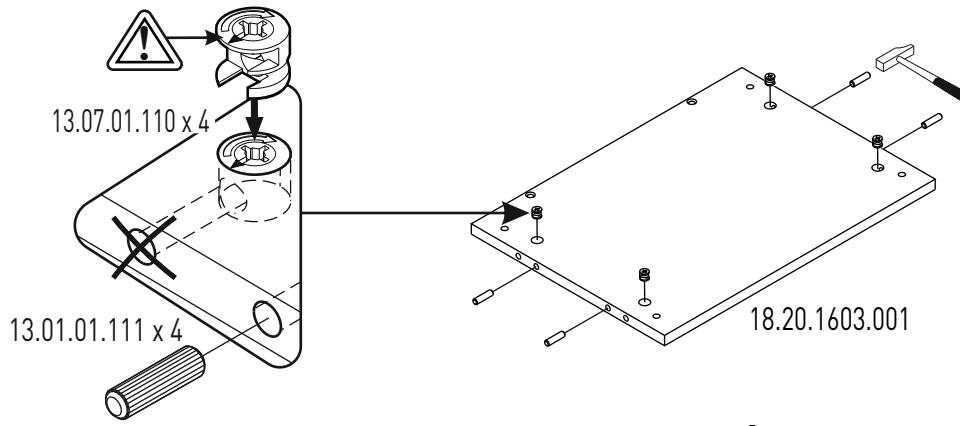

1

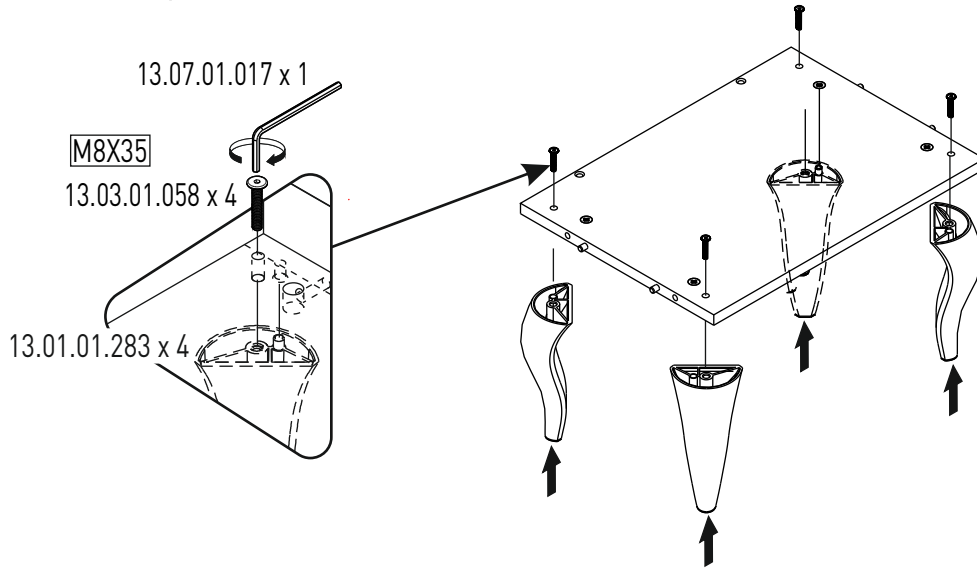

1

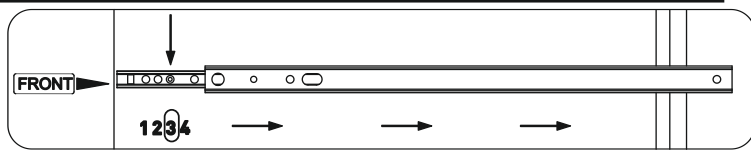

2

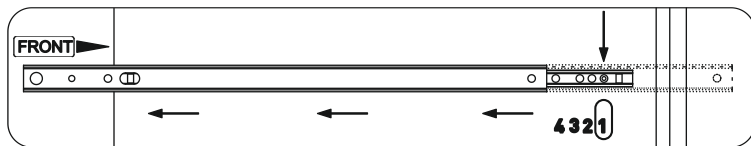

2

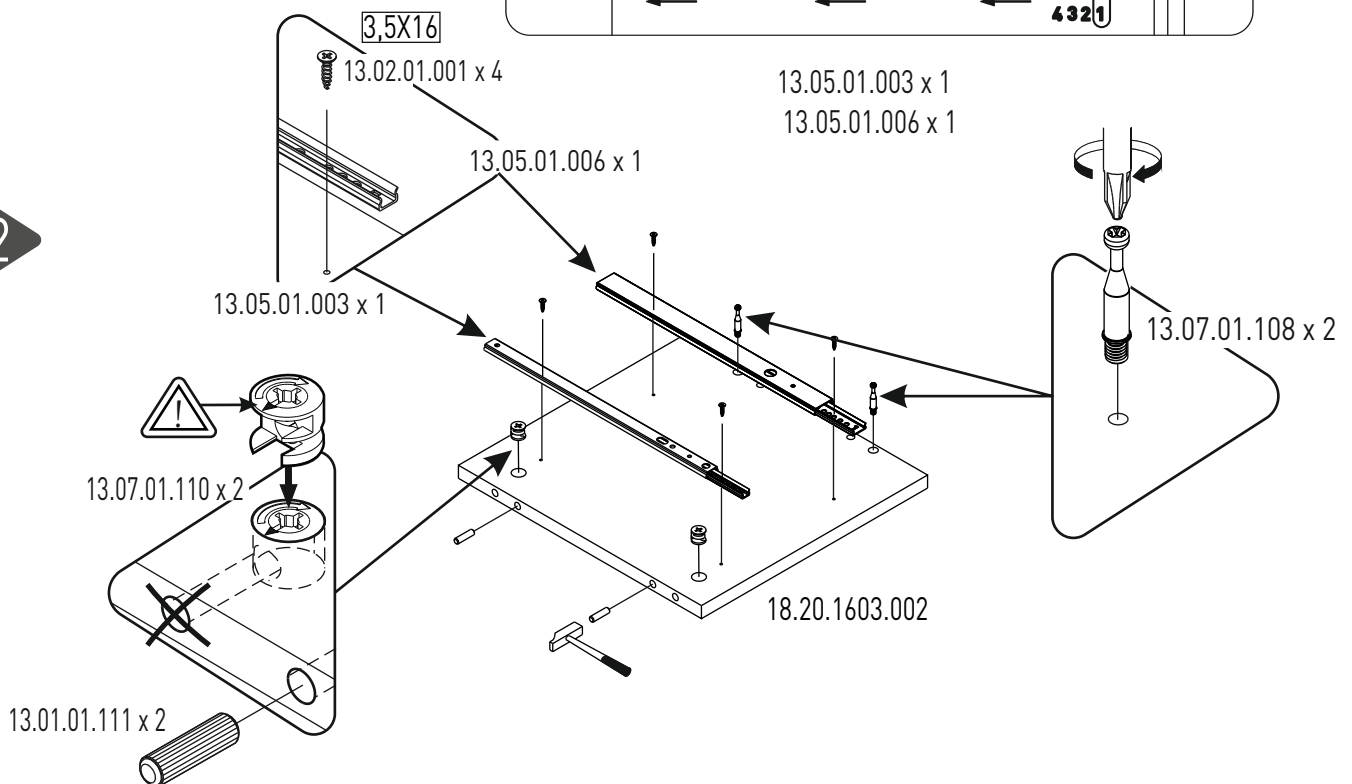

1

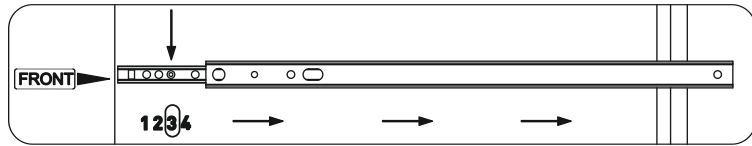

2

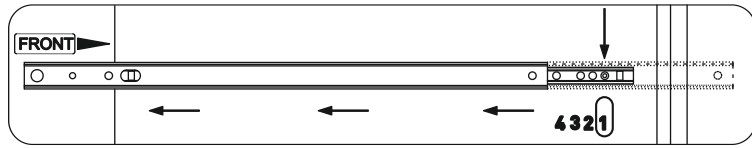

3

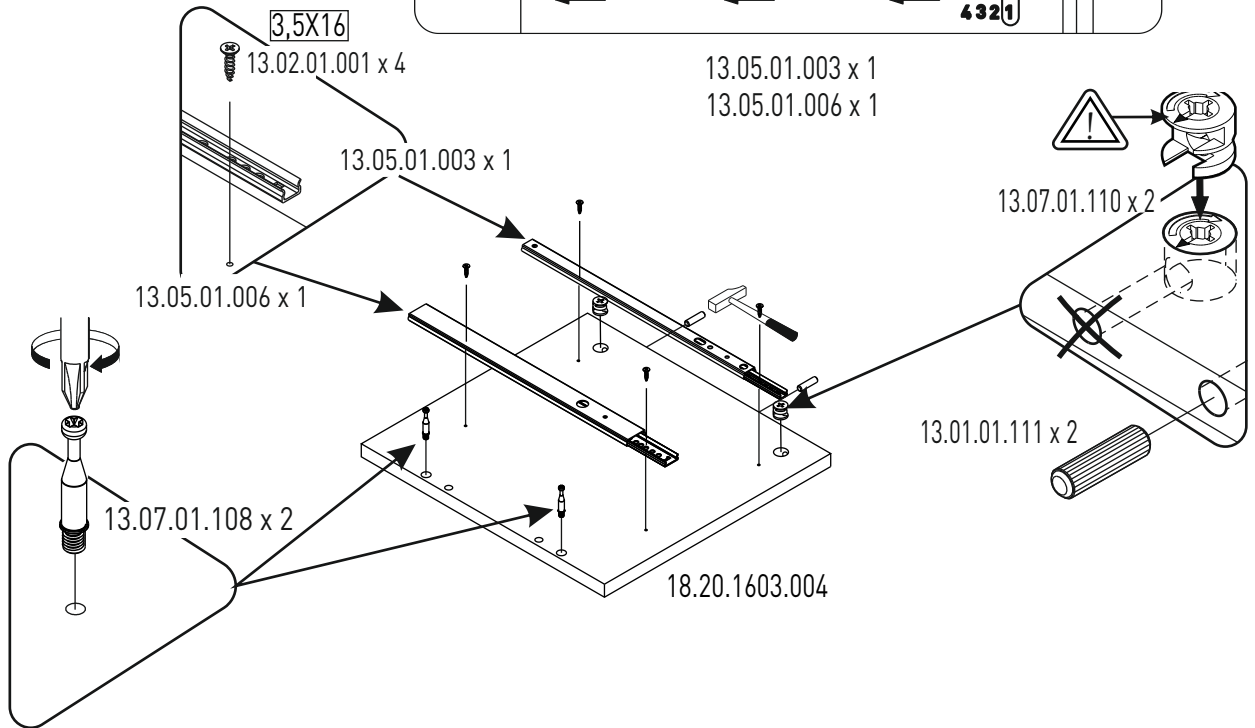

4

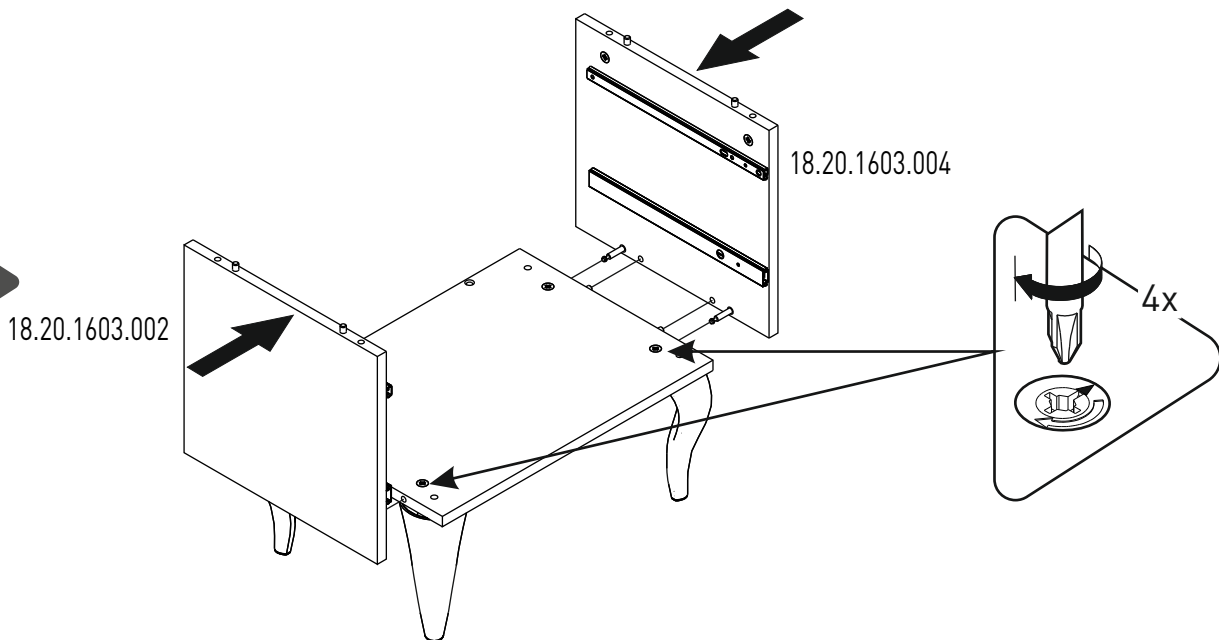

5

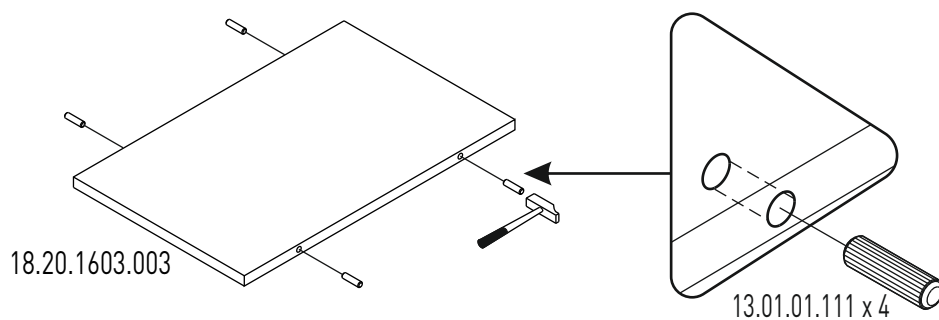

6

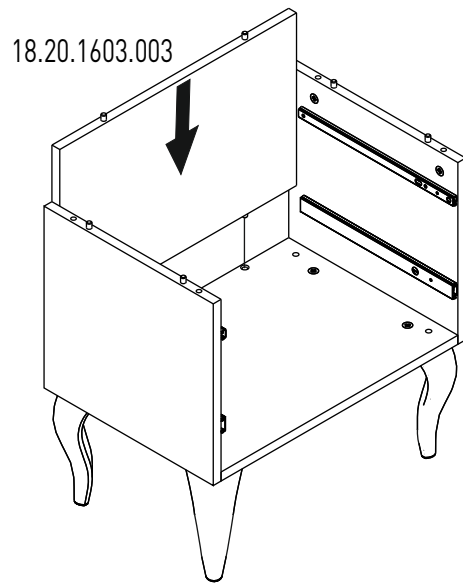

7

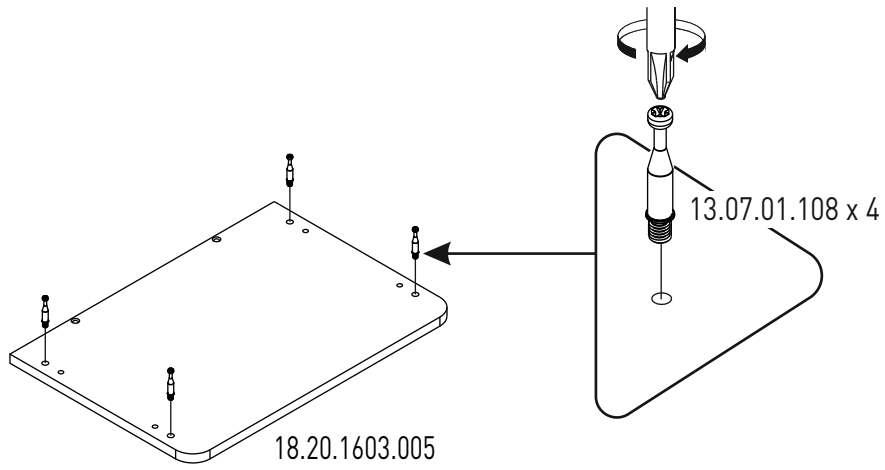

8

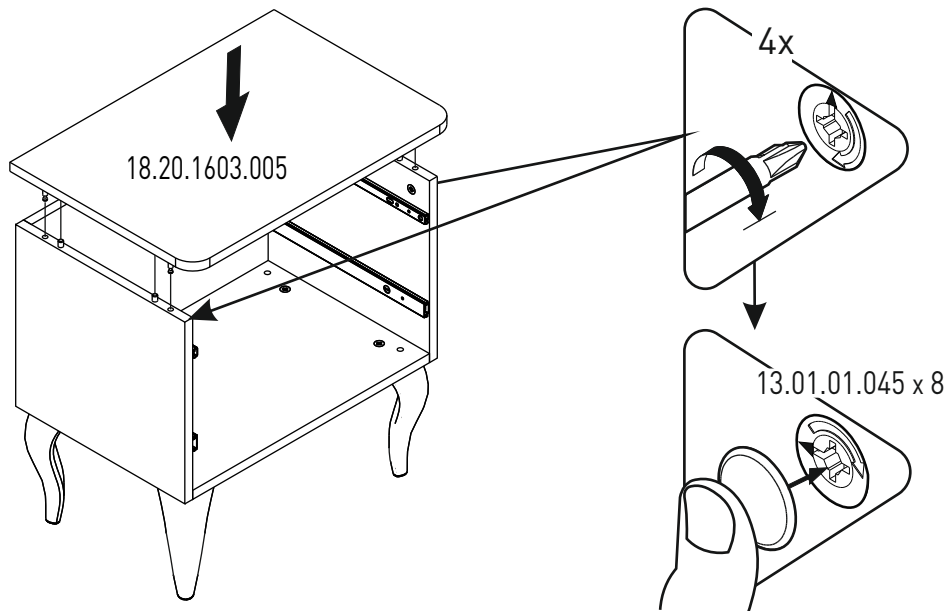

9

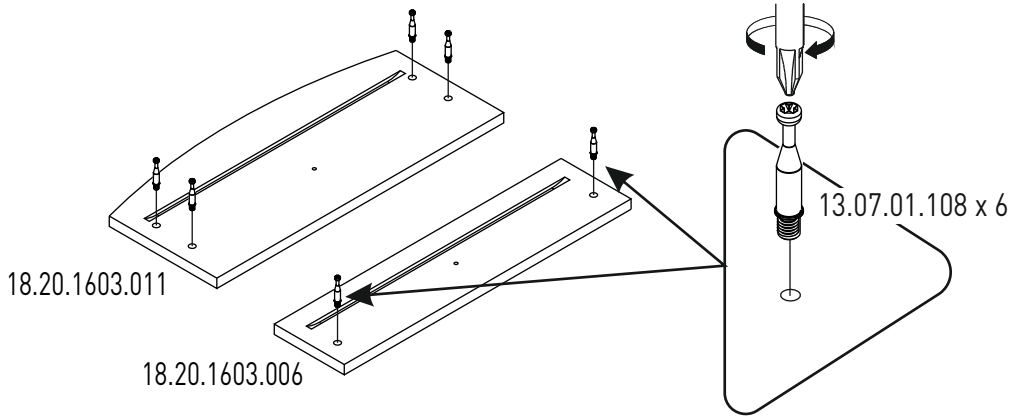

10

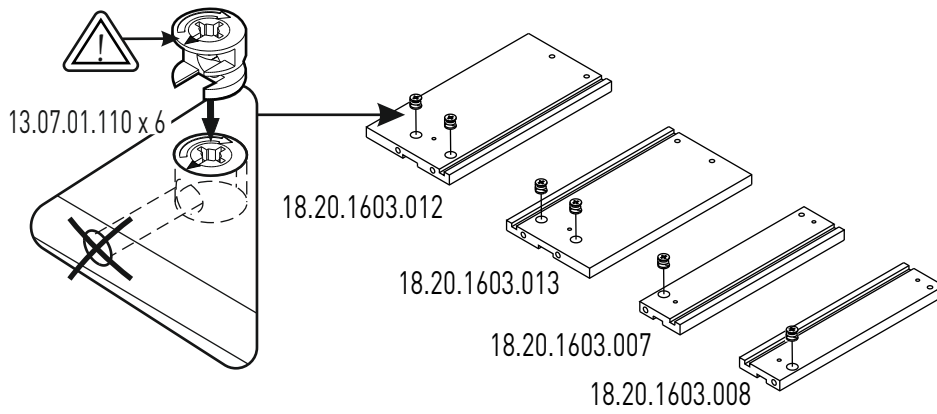

11

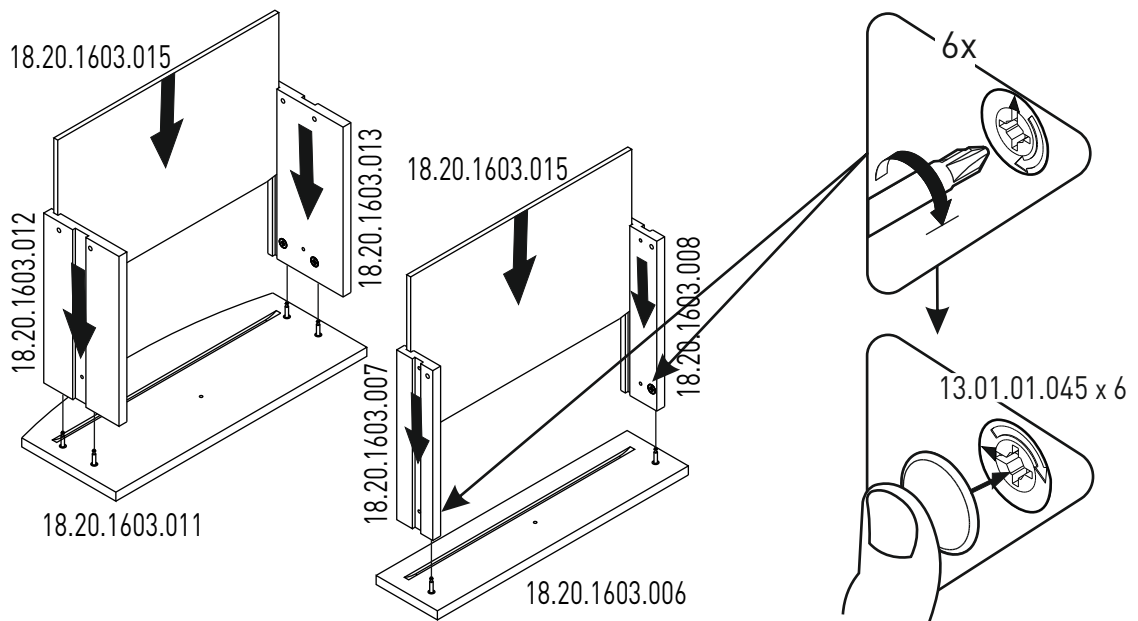

12

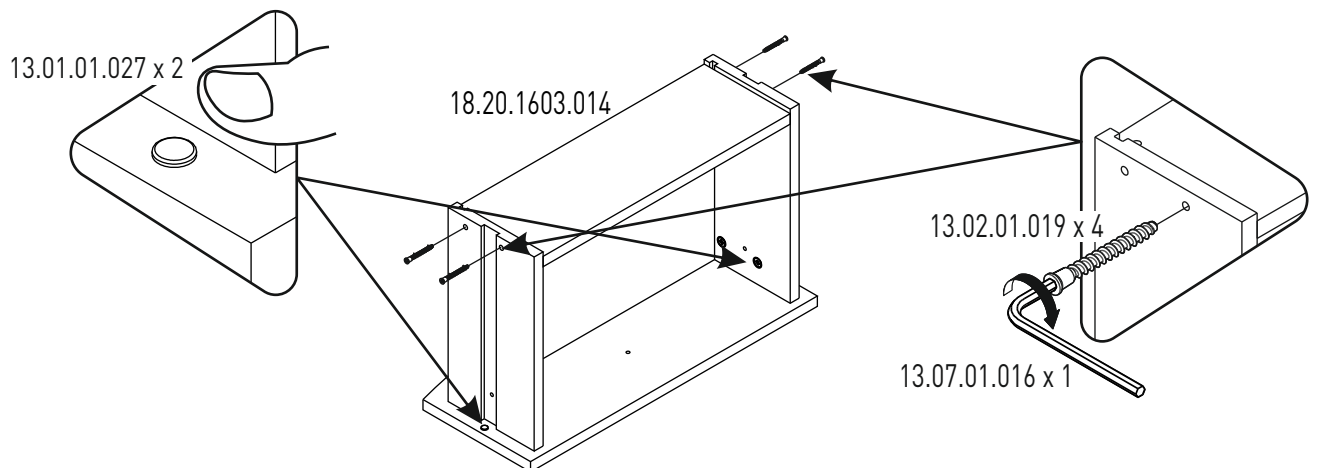

13

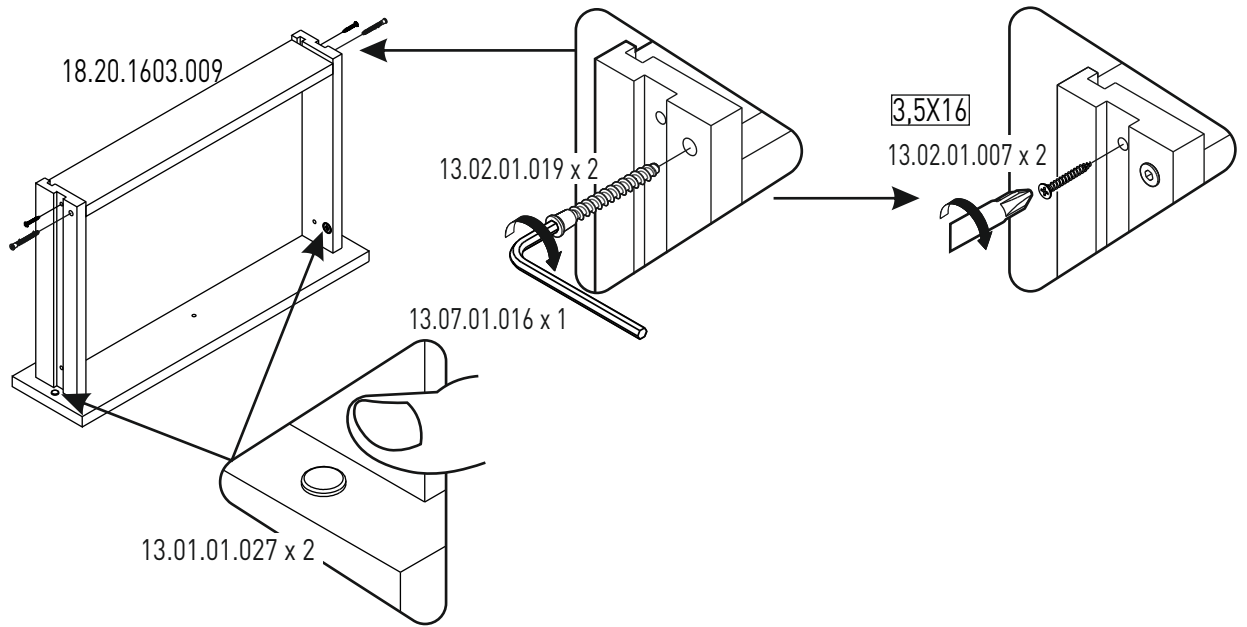

14

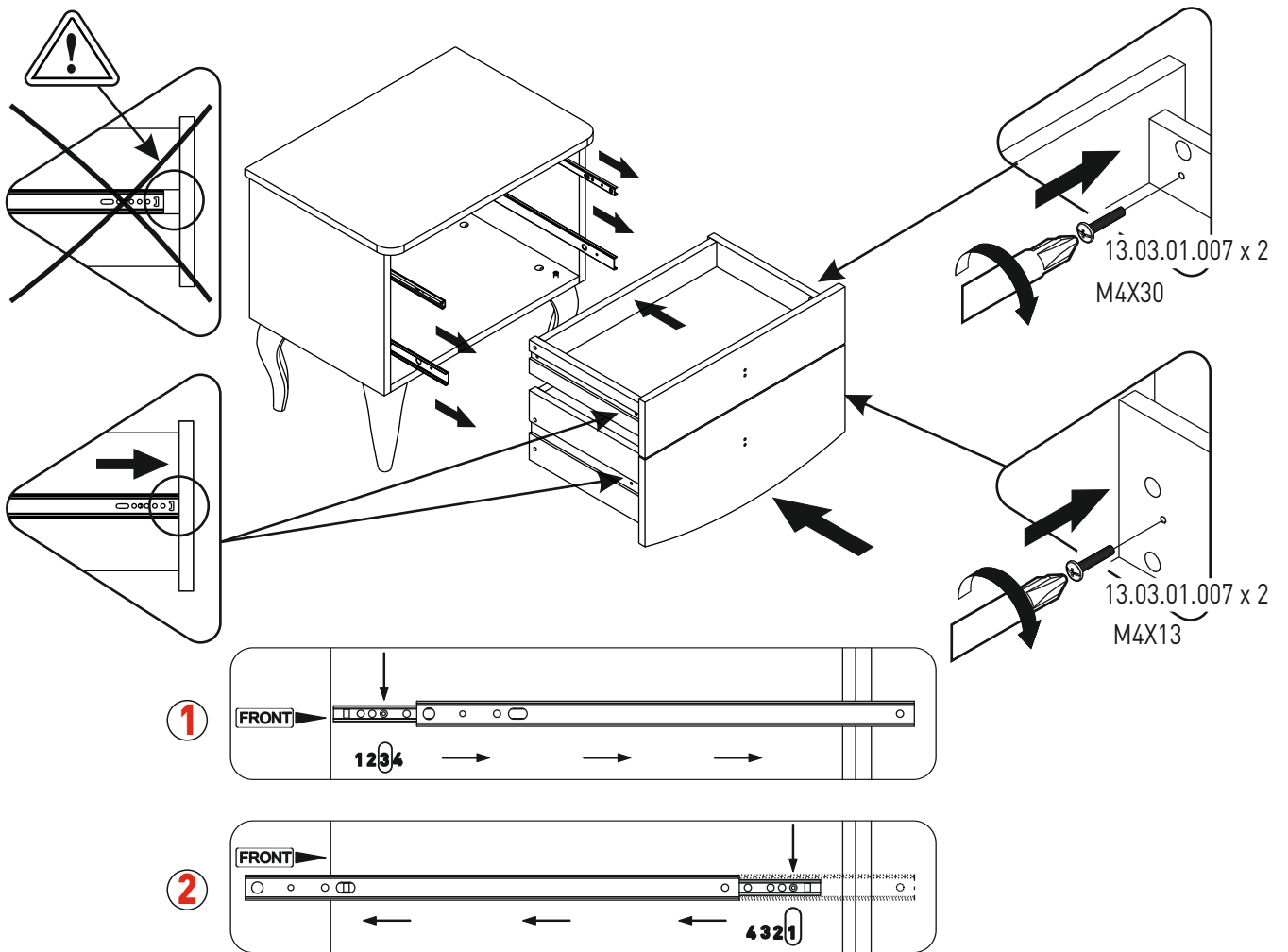

15

